

# VA140/150

## RANGE

### Axial Kitchen Fans

Installation and wiring Instructions

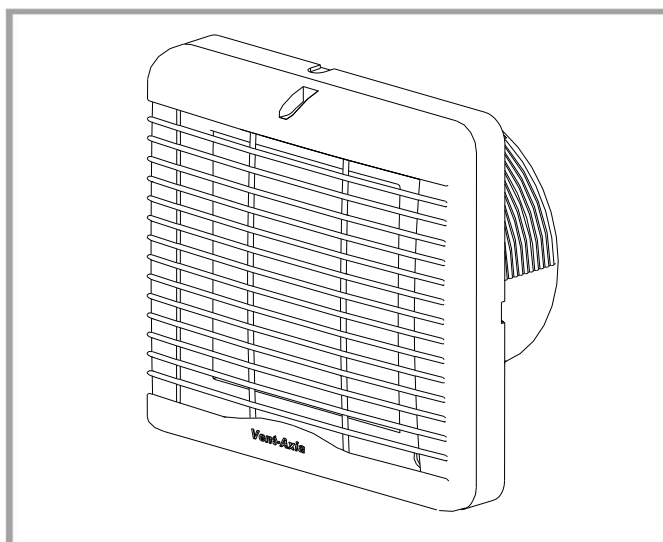

#### Stock Ref.No

VA140/150KP	140120C
VA140/150KT	140220C
VA140/150KHP	140320C
VA140/150KHT	140420C

220-240V~50Hz

**Vent-Axia®**

READ IN CONJUNCTION WITH ILLUSTRATIONS  
PLEASE SAVE THESE INSTRUCTIONS

CE



**IMPORTANT:  
READ THESE INSTRUCTIONS BEFORE COMMENCING THE INSTALLATION**

DO NOT install this product in areas where the following may be present or occur:

- Excessive oil or a grease laden atmosphere.
- Corrosive or flammable gases, liquids or vapours.
- This appliance is not suitable for installation in a shower cubical or enclosure and must be sited away from any source of water spray, and must be out of reach of a person using a fixed bath or shower.
- Ambient temperatures higher than 40°C or less than -5°C.
- Possible obstructions which would hinder the access or removal of the Fan.
- Sudden ductwork bends or transformations close to the Fan.

**SAFETY AND GUIDANCE NOTES**

- All wiring to be in accordance with the current I.E.E. Regulations, or the appropriate standards of your country and **MUST** be installed by a suitably qualified person.
- The Fan should be provided with a local all pole isolator switch having a contact separation of at least 3mm.
- Ensure that the mains supply (Voltage, Frequency, and Phase) complies with the rating label.
- The Fan should only be used in conjunction with the appropriate Vent-Axia products.
- It is recommended that the connection to the fan connector terminals is made with flexible cable.
- When the Fan is used to remove air from a room containing a fuel-burning appliance, ensure that the air replacement is adequate for both the fan and the fuel-burning appliance.
- This appliance is not intended for use by persons (including children) with reduced physical, sensory or mental capabilities, or lack of experience and knowledge, unless they have been given supervision or instruction concerning use of the appliance by a person responsible for their safety.
- Young children should be supervised to ensure that they do not play with the appliance.

**DESCRIPTION**

The VA140/ 150 Utility/ Kitchen fan is suitable for Panel either in a horizontal or vertical plane, Wall or Window mounting as standard. Additional Window (14 09 01A) and Wall (14 09 02A White / 14 09 03A Brown) kits are available.

- [A] Indoor Grille.
- [B] Inner Cover.
- [C] Cable Grommet.
- [D] Base Housing.
- [E] Telescopic Wall Liner.
- [F] Outside Grille.
- [G] Spacers (Window Kit).
- [H] Gasket (Window Kit).
- [I] Fixing Ring (Window Kit).
- [J] Grille Plate (Window Kit).

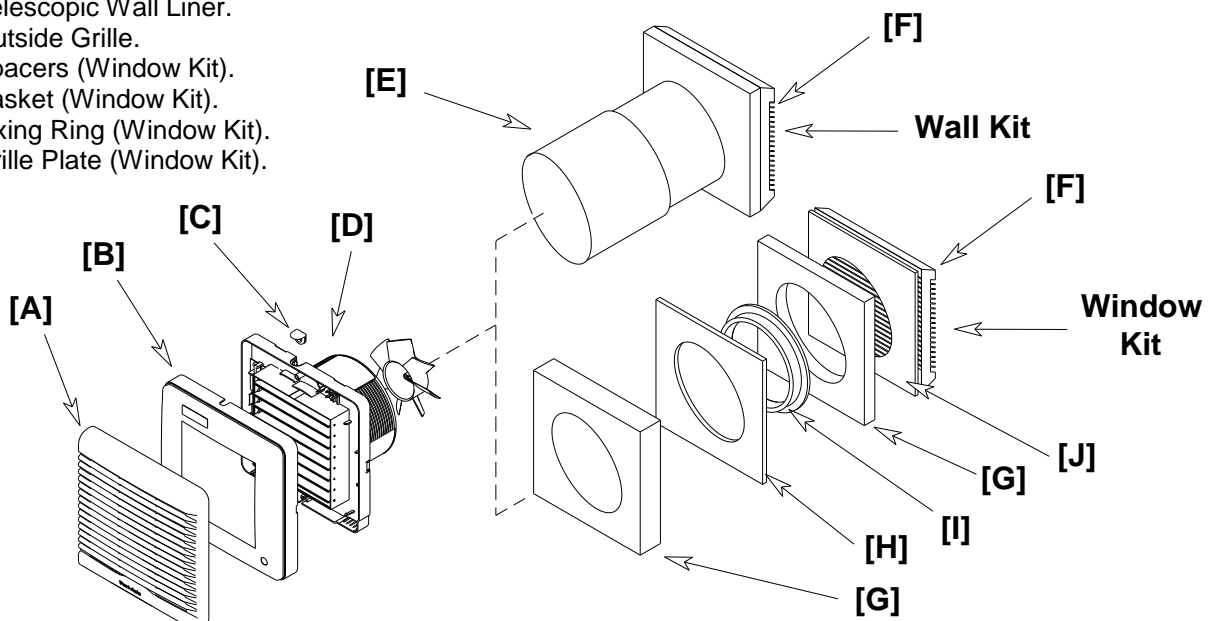

## A INSTALLATION.

### PANEL MOUNTING

1. Cut a 152mm $\varnothing$  hole through the panel. (Suitable for existing holes up to 185mm $\varnothing$ ).
2. Remove the Indoor Grille [A]. Loosen the screw (top middle) of the Grille, to release front grille gently lever the Grille downwards away from the Inner Cover [B].
3. Remove Inner Cover [B]. Loosen the screw (bottom middle) and release the inner grille gently from the Base Housing [D].
4. Remove the Cable Grommet [C], pierce/cut a hole in the Grommet to suit the cable size, maintaining the integrity of the seal and replace the grommet in the Base Housing to suit either a top or back cable entry.
5. Slide the Base Housing into the hole in the panel and secure into position using screws and fixings provided.

**Fig. 1.**

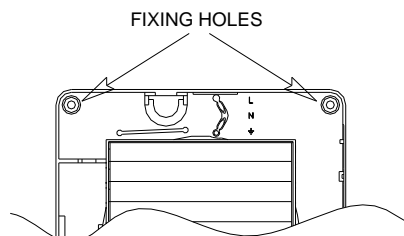

6. Ensure the fan blade rotates freely.
7. Select and follow the appropriate wiring diagram in **Section B WIRING**.
8. Replace the Inner Cover and Indoor Grille (retightening the screws securely).
9. Switch the mains power supply on and check the fan is operating correctly.

### WALL MOUNTING

1. Cut a 152mm $\varnothing$  hole through the wall and insert the wall sleeve [E] with the larger diameter sleeve on the room side and cement both ends into position flush with the wall faces. The wall sleeve should be angled downwards away from the fan to allow any condensation to drain to the outside wall.
2. Remove the Wall Mounting Plate from the Outside Grille [F] to use as a template, mark the fixing hole centres on the wall. Drill and plug the wall and fix the Wall Mounting Plate into position (screws provided).
3. Fix the Outside Grille [F] back onto the Wall Mounting Plate. Ensure the louvres are pointing downwards.
4. Remove the Indoor Grille [A]. Loosen the screw (top middle) of the Grille, to release front grille gently lever the Grille downwards away from the Inner Cover [B].
5. Remove Inner Cover [B]. Loosen the screw (bottom middle) and release the inner grille gently from the Base Housing [D].
6. Remove the Cable Grommet [C], pierce/cut a hole in the Grommet to suit the cable size, maintaining the integrity of the seal and replace the grommet in the Base Housing to suit either a top or back cable entry.
7. Slide the Base Housing into the Wall Liner and secure into position using screws and fixings provided (*Fig. 1.*).
8. Ensure the fan blade rotates freely.
9. Select and follow the appropriate wiring diagram in **Section B WIRING**.
10. Replace the Inner Cover and Indoor Grille (retightening the screws securely).
11. Switch the mains power supply on and check the fan is operating correctly.

### WINDOW MOUNTING

1. Cut a 152mm $\varnothing$  hole in the glass (Suitable for existing holes up to 185mm $\varnothing$ ).
2. Ensure that the glass surfaces are clean and free from grease.
3. Remove the Indoor Grille [A]. Loosen the screw (top middle) of the Grille, to release front grille gently lever the Grille downwards away from the Inner Cover [B].
4. Remove Inner Cover [B]. Loosen the screw (bottom middle) and release the inner grille gently from the Base Housing [D].
5. Remove the Cable Grommet [C], pierce/cut a hole in the Grommet to suit the cable size, maintaining the integrity of the seal and replace the grommet in the Base Housing to suit a top cable entry.
6. Fit required spacers behind the fan back plate, engaging the locating pips. Place the fan spigot through the hole in the glass from the inside, with a gasket on each side of the glass.
7. From the outside, place on the remaining spacer, with the locating pips facing outwards. For double-glazing and materials up to 40mm thick, one or more spacers may be discarded. (*Fig. 2.*)
8. Draw the assembly together with the threaded fixing ring. Do not over-tighten.
9. Fix the Outside Grille [F] on to the Spacers (screws provided). Ensure the louvres are pointing downwards.
10. Ensure the fan blade rotates freely.
11. Select and follow the appropriate wiring diagram in **Section B WIRING**.
12. Replace the Inner Cover and Indoor Grille (retightening the screws securely).
13. Switch the mains power supply on and check the fan is operating correctly

# Vent-Axla.

Fig. 2.

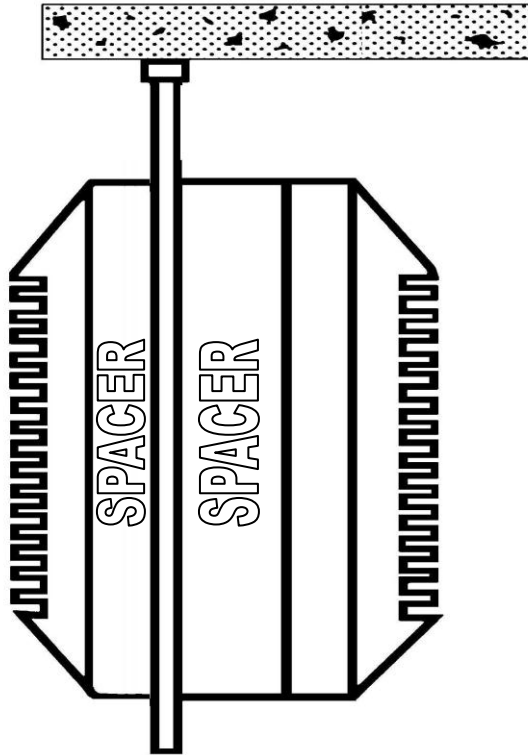

1. On the outside, one SPACER will always be required. Dependant on the thickness of glass either the thick or thin spacer will be used.
2. For thin (single glaze) glass the additional spacer should be fitted on the inside behind the fan, engaging the locating pips.

Ensure a gasket is fitted on each side of the glass.

## B. WIRING.



**WARNING: THE FAN AND ANY ANCILLARY CONTROL EQUIPMENT MUST BE ISOLATED FROM THE POWER SUPPLY DURING THE INSTALLATION / OR MAINTENANCE.**

1. Select and follow the appropriate wiring diagram (Fig. 3-6).
2. Check all connections have been made correctly and ensure all terminal connections and cable clamps are securely fastened.
3. The cable entry must be made using the cable grommet.
4. Ensure the impeller rotates and is free from obstructions.

Fig. 3.

VA140/ 150KP Pullcord Model.

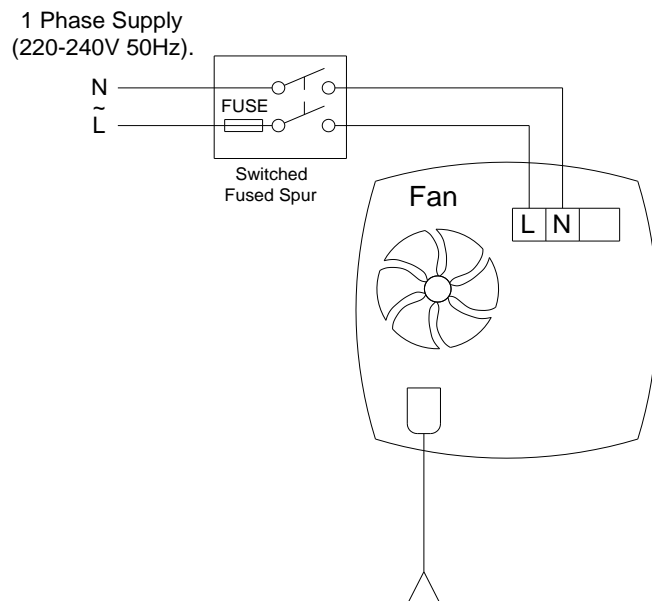

**Fig. 4.**  
**VA140/ 150KT Timer Model.**

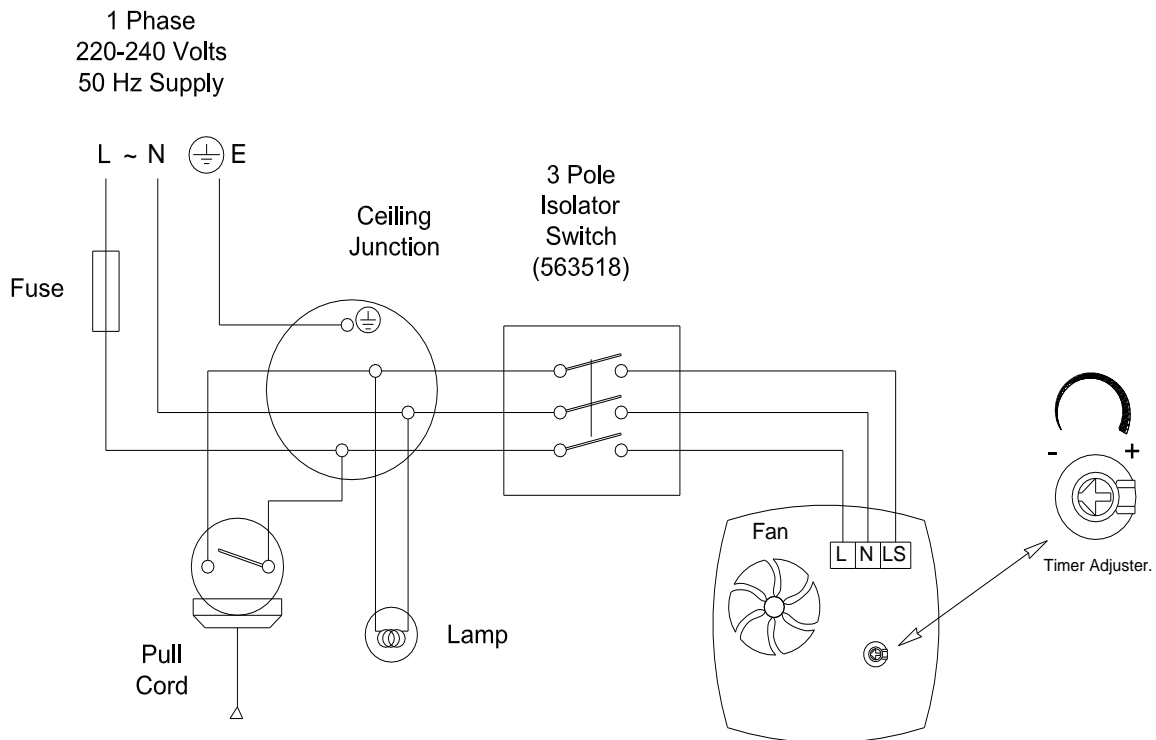

### Timer Adjustment.

The overrun time period is factory set to approximately 15 minutes. The overrun time period may be adjusted at installation from 5-30 minutes, by altering the adjuster on the Fan PCB.

### Before adjusting the timer, switch off the Mains Supply.

1. Remove the Indoor Grille [A]. Loosen the screw (top middle) of the Grille, to release front grille gently lever the Grille downwards away from the Inner Cover [B].
2. Remove Inner Cover [B]. Loosen the screw (bottom middle) and release the inner grille gently from the Base Housing [D].
3. To REDUCE the operating time, turn the Timer Adjuster ANTI-CLOCKWISE.
4. To INCREASE the operating time, turn the Timer Adjuster CLOCKWISE.
5. Replace the Inner Cover and Indoor Grille.
6. Reconnect the mains supply.

**Fig. 5.**  
**VA140/ 150KHP Humidity Model.**

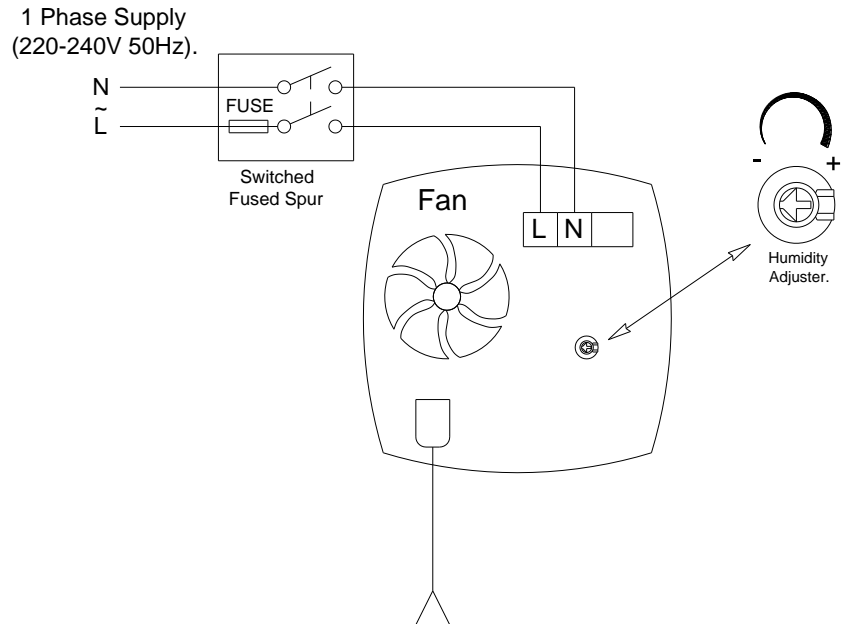

**Humidity Set-Point Adjustment.**

The Fan's Humidity Set-Point is factory set to switch the fan on at approximately 72%RH. The sensitivity may be adjusted at installation from 65%RH-90%RH, by altering the adjuster on the Fan PCB.

**Before adjusting the Set-Point, switch off the Mains Supply.**

1. Remove the Indoor Grille [A]. Loosen the screw (top middle) of the Grille, to release front grille gently lever the Grille downwards away from the Inner Cover [B].
2. Remove Inner Cover [B]. Loosen the screw (bottom middle) and release the inner grille gently from the Base Housing [D].
3. To LOWER the Set-Point, turn the adjuster ANTI-CLOCKWISE. This makes the fan more sensitive to RH%, i.e. the fan will come on at a lower RH%.
4. To RAISE the Set-Point, turn the adjuster CLOCKWISE. This makes the fan less sensitive to RH%, i.e. the fan will come on at a higher RH%.
5. Replace the Inner Cover and Indoor Grille.
6. Reconnect the mains supply.

(If remote override is required refer to Fig 6 for installation. The remote switch will switch between automatic humidity control and manual override. Ignore the timer control potentiometer in the diagram)

**Fig. 6.**  
**VA140/ 150KHT Humidity Timer Model.**

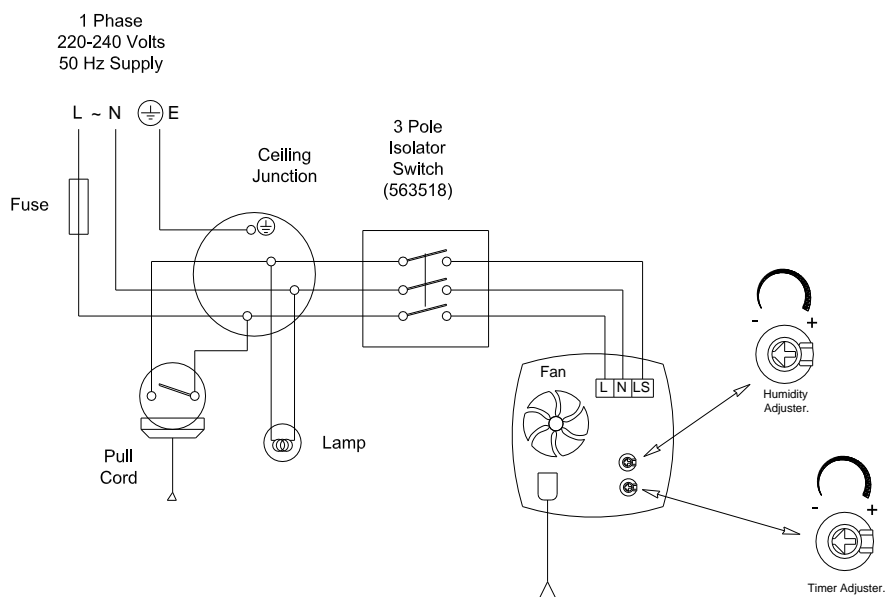

**Humidity and Time Set-Point Adjustment.**

The fan's Humidity Set-Point is factory set to switch the fan on at approximately 72%RH. The sensitivity may be adjusted from 65%RH - 90%RH, by altering the adjuster on the Fan PCB.  
The overrun Time period is factory set to approximately 15 minutes. The overrun time period may be adjusted from 5-30 minutes, by altering the adjuster on the Fan PCB.

**Before adjusting the Set-Point, switch off the Mains Supply.**

1. Remove the Indoor Grille [A]. Loosen the screw (top middle) of the Grille, to release front grille gently lever the Grille downwards away from the Inner Cover [B].
2. Remove Inner Cover [B]. Loosen the screw (bottom middle) and release the inner grille gently from the Base Housing [D].
3. To LOWER the Set-Point/ operating time, turn the indicated adjuster ANTI-CLOCKWISE. This makes the fan more sensitive to RH%, i.e. the fan will come on at a lower RH% or will reduce the overrun time.
4. To RAISE the Set-Point/ operating time, turn the adjuster CLOCKWISE. This makes the fan less sensitive to RH%, i.e. the fan will come on at a higher RH% or will increase the overrun time.
5. Replace the Inner Cover and Indoor Grille.
6. Reconnect the mains supply.

**Shutter Operation**

The shutter mechanism in all VA140/ 150 range fans will open approximately 40 seconds after the fan is turned On. The shutter will close about a minute after the fan is switched Off.

**C. SERVICING AND MAINTENANCE.**

**WARNING: THE FAN AND ANCILLARY CONTROL EQUIPMENT MUST BE ISOLATED FROM THE POWER SUPPLY DURING MAINTENANCE.**

1. At intervals appropriate to the installation, the fan should be inspected and cleaned to ensure there is no build up of dirt or other deposits.
2. Remove the Indoor Grille (See Section A : 2 for instructions) and wash in warm soapy water.
3. Wipe the shutter blades with a damp cloth until clean.
4. Replace the Grille.

## The **Vent-Axia**® Guarantee

Applicable only to products installed and used in the United Kingdom. For details of guarantee outside the United Kingdom contact your local supplier.

Vent-Axia guarantees its products for two years from date of purchase against faulty material or workmanship. In the event of any part being found to be defective, the product will be repaired, or at the Company's option replaced, without charge, provided that the product:-

- Has been installed and used in accordance with the instructions given with each unit.
- Has not been connected to an unsuitable electricity supply. (The correct electricity supply voltage is shown on the product rating label attached to the unit).
- Has not been subjected to misuse, neglect or damage.
- Has not been modified or repaired by any person not authorised by the company.

### IF CLAIMING UNDER TERMS OF GUARANTEE

Please return the complete product, carriage paid to your original supplier or nearest Vent-Axia Centre, by post or personal visit. Please ensure that it is adequately packed and accompanied by a letter clearly marked "Guarantee Claim" stating the nature of the fault and providing evidence of date and source of purchase.

The guarantee is offered to you as an extra benefit, and does not effect your legal rights

# **Vent-Axia**®

Head Office: Fleming Way, Crawley, West Sussex, RH10 9YX.

**UK NATIONAL CALL CENTRE**, Newton Road, Crawley, West Sussex, RH10 9JA

SALES ENQUIRIES: Tel: 0844 8560590 Fax: 01293 565169

TECHNICAL SUPPORT: Tel: 0844 8560594 Fax: 01293 532814

For details of the warranty and returns procedure please refer to [www.vent-axia.com](http://www.vent-axia.com) or write to Vent-Axia Ltd, Fleming Way, Crawley, RH10 9YX