

# HR100R

Mini Air Handling Unit -

For Ducted Ventilation With Heat Recovery

***Vent-Axia***<sup>®</sup>  
***Clean Air Systems***

---

## Installation and Servicing Instructions

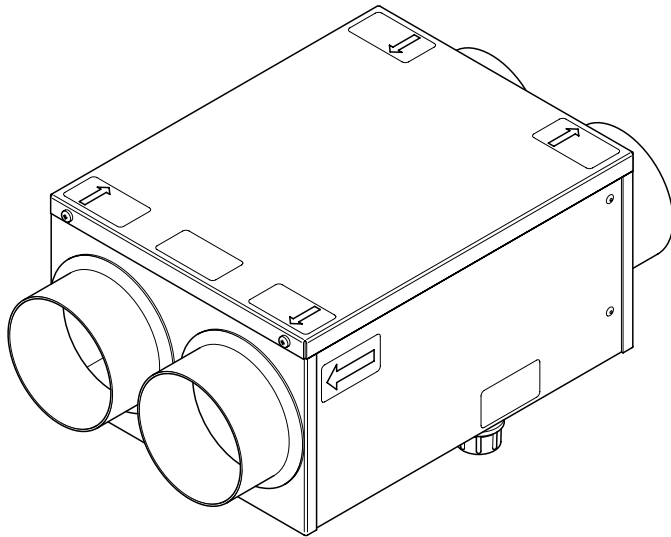



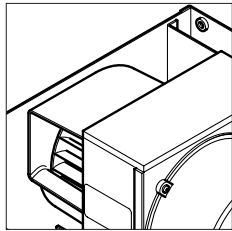
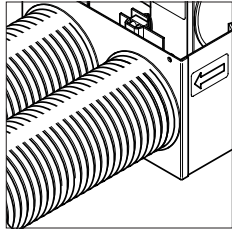
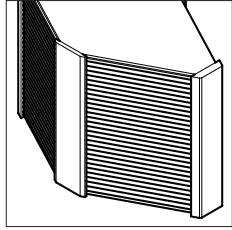

## Contents

Section	Page
<b>1.0 Introduction</b>	<b>4</b>
<b>2.0 Site Requirements</b>	<b>5</b>
<b>3.0 Installation</b>	<b>6</b>
<b>4.0 Electrical</b>	<b>10</b>
<b>5.0 Commissioning</b>	<b>11</b>
<b>6.0 Maintenance</b>	<b>12</b>
<b>7.0 Optional Extras</b>	<b>13</b>
<b>8.0 Notes</b>	<b>14</b>

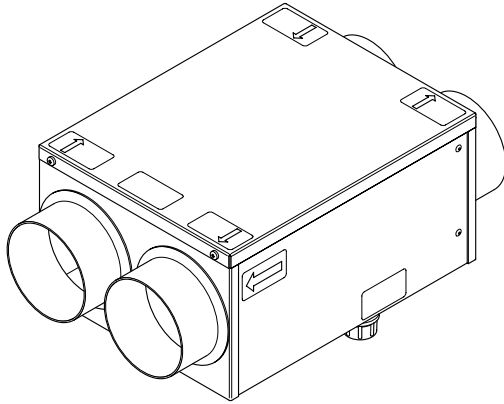

## 1.0 Introduction

---

### 1.1 Description

The Vent-Axia HR100R is a remote mounting unit to provide balanced ventilation with up to 70% heat recovery for applications where there is no immediate access to an external wall. The HR100R is ideal for installations involving internal bathrooms and meets building regulation requirements for this application.

A two speed motor provides for constant low rate ventilation with a boost speed option. Fresh pre-warmed air from outside is continually provided to the room with simultaneous extraction of stale air and smells. Heat is transferred from outgoing air to the fresh air supply with zero cross contamination, maintaining internal temperatures and providing a fresh environment.

---

## 2.0 Site Requirements

---

### 2.1 Information

1. The unit must be sited and connected by a suitably qualified person and be in accordance with current U.K. Building Regulations and I.E.E. Wiring Regulations (BS 7671).
  2. The unit is intended for permanent connection to the mains electrical supply.
  3. The HR100R is intended for fixed wiring installation.
  4. Ensure that the mains electrical supply is compatible with the product's rating label.
  5. The unit must be sited away from direct sources of heat in excess of 40°C.
  6. Do not site the ceiling diffusers in the vicinity of excessive levels of airborne oil or grease.
  7. If the ceiling diffusers are installed in a room containing a fuel burning appliance, the installer must ensure that air replacement is adequate for both appliances.
  8. The external grilles must be sited a minimum of 500mm away from the flue of gas or open fire appliances. This is to avoid back flow of gases entering the room.
  9. All safety regulations and requirements must be strictly followed to prevent hazards to life and property both during and after installation and during subsequent maintenance or servicing.
  10. Ensure the mains electrical supply is isolated before commencing installation, or maintenance.
-

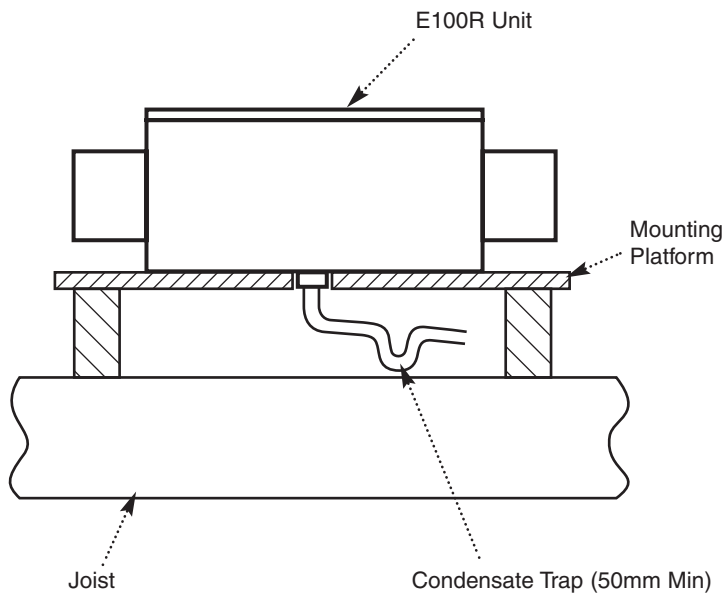

## 3.0 Installation

### 3.1 Installing the Unit

1. Check that all components have been delivered, as identified in the delivery note. Notify the supplier of any errors or omissions immediately.
2. Check the diagrammatic ducting layout drawing to ensure that the proposed duct routes, fan unit and air terminal locations can be accommodated. If in doubt, refer to the Technical Department.
3. The unit is designed to be mounted horizontally. After noting the positions of the electrical connector, duct spigots and drainage connection for the unit, choose a suitable installation site for the unit. The most desirable location for the unit is normally within the roof space.
4. Never locate the unit above a sleeping area. The most suitable position is normally above the landing or bathroom. The selected site must allow adequate space around the unit for the removal of the access panel and heat exchanger for maintenance and servicing purposes.
5. When installing the unit, a suitable platform must be made. This should be built from chipboard or blockboard (19mm preferred). This board should be raised enough to facilitate the mounting of the unit above joist level.
6. The unit must be positioned so that the condensate outlet can be trapped and the condensate conveyed properly with a continuous gradient to discharge through the gable or to the eaves gutter in the selected location.
7. Connect the drainage system as appropriate using PVC pipework, joined using PVC cement to ensure of watertight joints.  
N.B. The trap should be charged/filled before operating the system, and should be checked especially in summer. Also note that a blocked condensate outlet pipe due to insufficient pipe gradient will quickly lead to water damage.
8. A shell bit is recommended for drilling holes in the ceiling to accommodate the housings for supply and extract air terminals (SV100 and EV100). Make sure that you are not drilling into structural members, water or gas pipes or electrical cables and that there is room behind the plaster board for duct access and securing ring. Ceiling terminals should preferably be fitted equidistant from adjacent walls bearing in mind that coving may already be fitted or may be fitted at a later date.

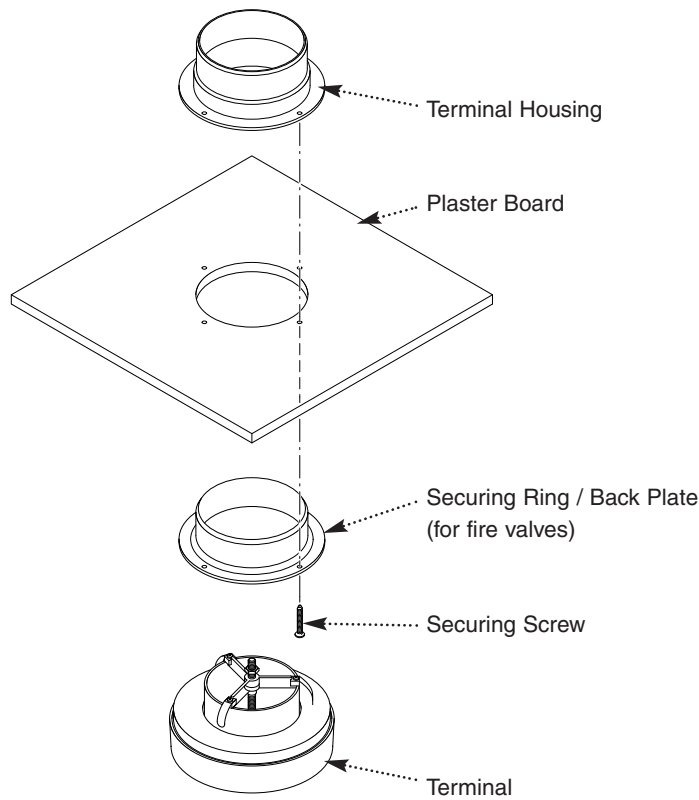

## 3.0 Installation

### 3.1 Installing the Unit

9. Place the terminal housing in the hole in the ceiling and secure to the back ring with the four screws provided.

10. For two storey new build properties it is recommended that the ground floor terminal housings are secured in position in advance of the plasterboard panels being fixed, by obtaining a sheet of plasterboard of the type and thickness to be used. Cut a square of the sheet to just span two joists in the corner where the terminal is to be fitted. Remember that the edge of the sheet on the inner joist should only rest on half of the joist thickness. This allows a fixing surface for the next sheet of plasterboard to be secured to when it is fitted. Tack up the plasterboard in position on the ceiling and connect up and seal the duct and fittings.

11. For two storey existing properties it is necessary to lift the floor coverings at first floor level above the terminal positions to gain access to the terminal housings to secure and seal the duct and fittings.

12. Fix in position all vertical supply and extract air ducting being conveyed between ground floor ceiling level and the loft space.

13. The external grilles for intake and exhaust air should be positioned so that the exhaust air is not drawn in again.

14. If the grilles are fitted in the same gable at the same height, a minimum of 1m between grilles is recommended.

15. If the grilles are positioned above one another the distance apart should be at least 1m with the exhaust grille at the top.

16. Roof ventilators placed on the same roof surface should be positioned at the same distances as the grilles.

17. Always ensure that all exhaust grilles/roof ventilators are placed higher than the top edge of the highest window and at a distance of at least 1m from the nearest window.

## 3.0 Installation

---

### 3.1 Installing the Unit

18. External grilles placed in the soffit should be positioned at the same distances as indicated for gables.

19. The Quicktube Rigid UPVC duct system permits fast, easy assembly whilst ensuring pressure-proof system sealing.

20. The ducts are delivered in lengths of 3m and are easily shortened as required with a duct saw or a similar fine toothed saw. We recommend that you file the edges of the ducts after shortening.

21. Assemble the duct and fittings, following as closely as possible the diagrammatic ducting layout. Ensure that the duct is raised above joist level to allow for thermal insulation of the ducting.

22. Each straight length of duct is assembled using a flexible connector (QTC) to join the two ends, whilst 90° and 45° diversions and branches are accomplished with flexible fittings (QTB90, QTB45 and QTET). The duct is a push fit into the socket of the connector and fittings.

23. Once assembled the joints are secured with duct tape (DT30) to provide an airtight seal. Ensure that the tape is secured over the complete joint area to provide an airtight seal.

24. If the loft space is unheated the unit and ducting will require to be thermally insulated to preclude condensation occurring and to minimise heat loss. This requirement must be observed in the planning and routing of the duct system.

25. The insulation recommended is Alreflex 1L1 which comprises 3mm thick polyethylene bubble sheet laminated on the external surface with aluminium foil protected by a thin polythene film. The product is CFC and HFC free and has a surface spread of flame of Class 1 tested to BS476 Part 7/971. It should, however, be protected from open flames or sparks and stored apart from highly flammable materials.

---



## 3.0 Installation

---

### 3.1 Installing the Unit

26. The material provides resistance to heat loss from the distribution ducting and a highly effective vapour barrier when all joints are sealed with metallised tape. It is light but robust, not easily damaged in storage or during construction and is rot proof, water and vapour resistant, durable and can be expected to remain an effective insulant for the normal life span of a building.

27. The insulation is supplied in 1.5m long preformed sections for application to the ducting at the time of installation. All joints should be secured using the metalised tape (DTA30) provided to ensure that a continuous vapour seal is maintained.

28. The use of flexible ducting should be limited to an absolute minimum. If used it should be fully stretched in order to minimise pressure loss.

29. Offer the unit on to the mounting surface, ensuring that it is not susceptible to movement under operation. Use directional airflow indicators on the top of the unit to ensure the correct connection to external and internal vents.

30. Mate up the ducting as appropriate, ensuring that the airflow is in line with the directional indicators.

31. Determine the most appropriate siting position for the appropriate control. Normally, this would either be a manual control switch (NBSW), pull-cord switch (PCSW) humidity switch (HS6) or speed control switch (VCON100).

32. Determine the appropriate wiring connections as outlined within section 4, and wire in accordance with current IEE Wiring Regulations, ensuring that the mains feed is isolated before making any connections.

---

# 4.0 Electrical

## 4.1 Electrical Connections

230V 50Hz 12W (normal) 31W (boost)

### Continuous Normal Speed

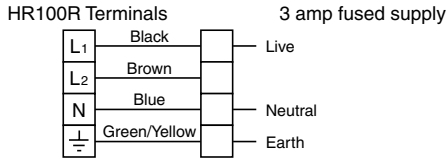

### Continuous Boost Speed

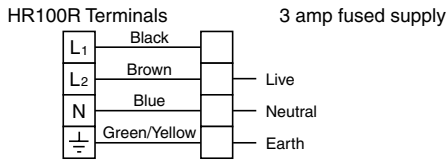

### VCON100: Manual Normal to Boost Speed Switching and ON/OFF Control

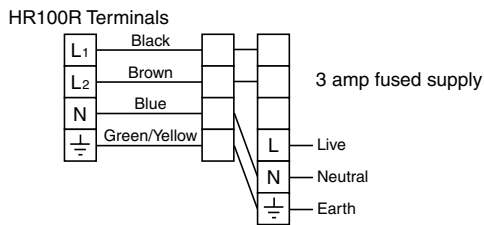

### NBSW and PCSW: Manual Normal to Boost Speed Control

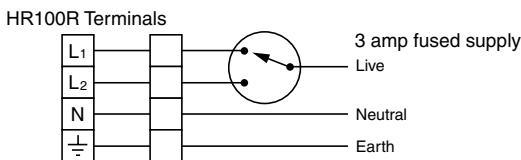

### HS6: Automatic Normal to Boost Speed Control

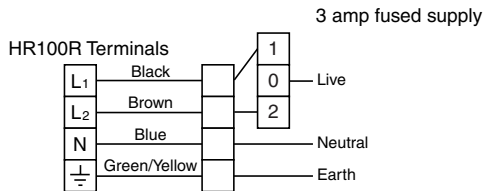

**NOTE:** Wiring must be via a 3A fused switched spur with a 3mm contact separation in each pole. The wiring should be suitably (BASEC or HAR) approved cable of appropriate current carrying capacity.

For units switching to boost on operation of a light switch, an in-line timer (order code TIM2) should be wired into the circuit as shown below.

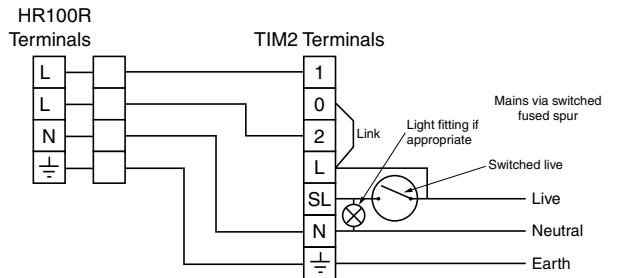

### Automatic Control

The HR100R unit operates on continuous trickle ventilation. Operation of switch turns unit to boost ventilation. When switch is turned off units continue to operate on boost for a preset period - adjustable 2-30 minutes.

The HR100R MUST NOT be wired in conjunction with a light switch, units will fail.

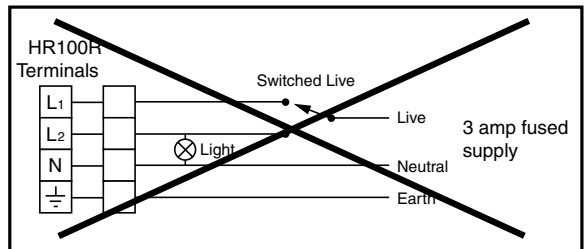

## 5.0 Commissioning

### 5.1 Commissioning the System

Before starting to commission the system check the following:

- a) All ducting is in place and secured.
- b) The wiring is secure and correctly connected.
- c) The trap is in position, charged and will enable efficient removal of condensate.
- d) The unit is mounted appropriately in a position not susceptible to movement or damage.

The scope of the commissioning procedure comprises:

1. Balancing the two airflows to achieve maximum heat exchanger efficiency.
2. Adjusting the two airflows to obtain the overall airflow rates and the individual terminal air flow rates as specified on the air change schedule.
3. An airflow meter must be used to set the correct airflows.

**NOTE:** The supply air terminal device is directional and incorporates a deflector plate. Ensure that the deflector plate is correctly positioned so that the active part of the terminal device is discharging to the room.

4. Set the control switch (NBSW or PCSW) to normal speed or set the humidistat (HS6) at maximum and check that air is flowing in the correct direction at each terminal point.
5. Standard ceiling terminals type EV100 and SV100 are adjusted by turning the central screw and are locked in the "set" position by the locknut.

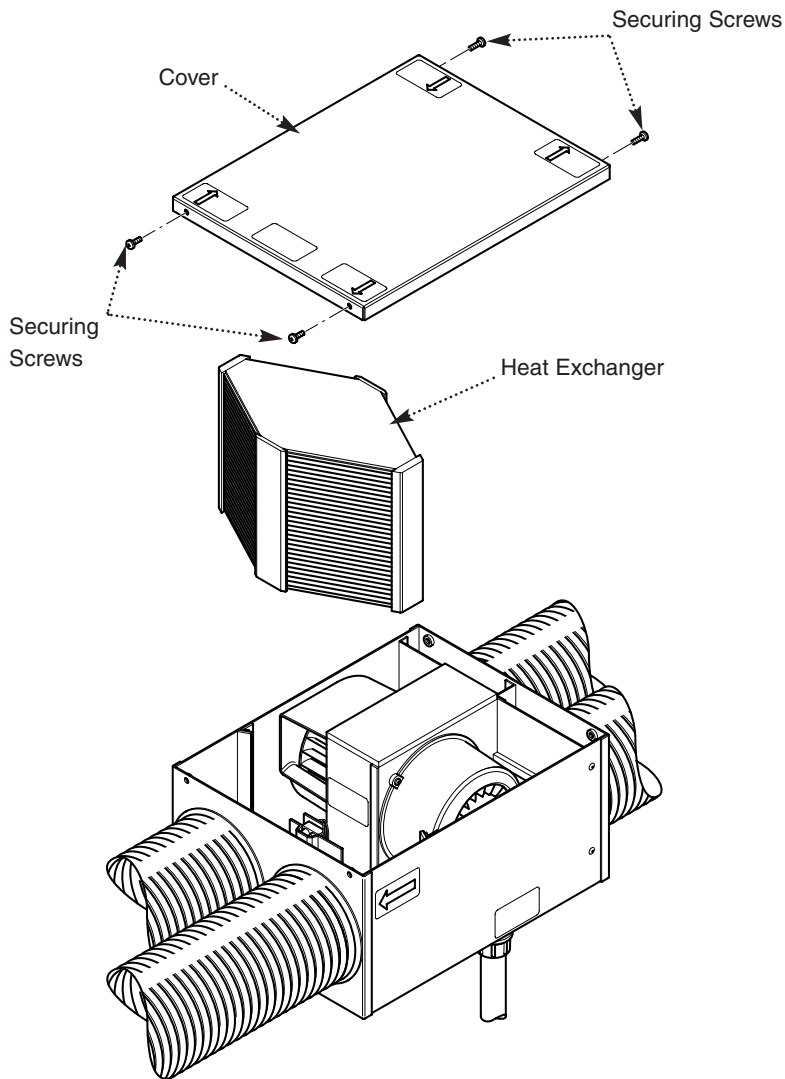

## 6.0 Maintenance

### 6.1 Cleaning the Unit

In addition to removing odours, providing fresh air and recovering heat, this unit extracts airborne impurities such as dust, dirt and grease. These gradually build up and detract from the efficiency and appearance of the unit.

To ensure optimum performance, the unit should be cleaned every three to six months or at periods determined by the level of contamination experienced, and according to the following procedure.

1. Isolate the mains power supply.
2. Remove the four securing screws from either end of the cover.
3. Remove the cover.
4. Remove the heat exchanger from the unit.
5. Wash the heat exchanger in warm water using a mild detergent and dry thoroughly. Keep water away from all electrical components and wiring within the unit. If the filter cannot be cleaned, replacement is recommended.
6. Reassemble in reverse order. The heat exchanger should be repositioned with the 'Top' label facing the front and pointing upwards.

## 7.0 Optional Extras

### 7.1 Ancillary Equipment

#### Speed Control Switch

##### Ref: VCON100

White plastic single gang switch for ON/OFF control and NORMAL/BOOST speed control of HR100R unit.

#### Speed Control Switch

##### Ref: NBSW

White plastic single gang switch for NORMAL/BOOST speed control of HR100R unit.

A metal black box for flushing mounting (Ref: MBB) and plastic back box for surface mounting (Ref: PBB) are available for use with the above controllers.

#### Pullcord Control Switch

##### Ref: PCSW

2 way ceiling mounted switch for NORMAL/BOOST speed control of HR100R unit. A second PCSW can also be used for ON/OFF control.

#### Humidity Sensor

##### Ref: HS6

Electronic humidity sensor with changeover relay output and adjustable switching point from 60% to 100% RH. In built temperature compensation (night time setback). Contamination protection sensor.

#### Timer

##### Ref: TIM2

Remote mounting timer box to provide ON/OFF control or switching between the 2 speeds on operation of switched live. Over-run period adjustable 2-30 minutes.

#### Internal Extract/Supply Grille

##### Ref: ESG100

White plastic louvre grille designed to fit in the wall or ceiling and serves both extract and supply functions. 100mm diameter spigot connection.

#### Internal Extract Valve

##### Ref: EV100

Adjustable extract valve with 80mm long, 100mm diameter spigot connection. Moulded in white plastic, the EV100 valve is suitable for both ceiling and wall mounting and is 150mm diameter overall.

#### Internal Supply Valve

##### Ref: SV100

Adjustable supply valve with 80mm long, 100mm diameter spigot connection. Valve design ensures horizontal discharge of air for optimum diffusion. Moulded in white plastic, the EV100 valve is suitable for both ceiling and wall mounting and is 150mm diameter overall.

#### Filter

##### Ref: F100

Coarse in-line filter complete with reticulated foam element. Compatible with 100mm diameter ducting.

#### External Push-Fit Wall Vent

##### Ref: WC1

400mm long brown plastic duct and external grille with vaned rubber seal for push fit installation in external walls. Fits into pre-drilled hole of 115mm diameter.

#### External Dual Wall Vent

##### Ref: WC2

Combined supply and extract terminal with grey plastic external cowl, with 100mm diameter ducting. This vent is ideal for exposed installations.

#### External Louvre Wall Box

##### Ref: WL100

Anodized aluminium external weather louvre with metal wall box 130 x 130mm and 174 x 174mm grille. 100mm diameter spigot connection.

#### Ventilating Roof Tiles

##### Ref: VT100

Moulded ventilation terminal tiles, available in a range of sizes, profiles and colours. 100mm diameter spigot connection.

#### In-Line Heater

##### Ref: ILH100

Compatible with 100mm ducting, the ILH100 provides a boost heat facility when required.

#### Flexible Ducting

##### Ref: AFD100

Aluminium ducting in 10m lengths.

##### Ref: ACD100

Acoustically insulated ducting in 6m lengths.

##### Ref: IFD100

Thermally insulated ducting in 6m lengths.

##### Ref: PFD100

PVC ducting in 6m lengths.

Quicktube 100mm rigid plastic ducting can also be used in conjunction with the HR100R unit. For details please see data sheet.





***Vent-Axia***<sup>®</sup>  

---

***Clean Air Systems***

Vent-Axia Ltd  
Fleming Way  
Crawley  
West sussex  
RH10 9YX  
[www.vent-axia.com](http://www.vent-axia.com)