

Lo-Carbon Centra

Continuous Extract Fan

Installation and Wiring Instructions



Stock Ref. N

442954B	Lo-Carbon Centra T
442955B	Lo-Carbon Centra HT
447127B	Lo-Carbon Centra TP
443045B	Lo-Carbon Centra HTP

220-240V~50Hz

Vent-Axia®

PLEASE READ INSTRUCTIONS IN CONJUNCTION WITH ILLUSTRATIONS.
PLEASE SAVE THESE INSTRUCTIONS.

IPX4





IMPORTANT: READ THESE INSTRUCTIONS BEFORE COMMENCING THE INSTALLATION

DO NOT install this product in areas where the following may be present or occur:

- Excessive oil or a grease laden atmosphere.
- Corrosive or flammable gases, liquids or vapours.
- Ambient temperatures higher than 40°C or less than -5°C.
- Possible obstructions which would hinder the access or removal of the Fan.

SAFETY AND GUIDANCE NOTES

- All wiring to be in accordance with the current I.E.E. Regulations, or the appropriate standards of your country and **MUST** be installed by a suitably qualified person.
- The Fan should be provided with a local isolator switch capable of disconnecting all poles, having a contact separation of at least 3mm.
- Ensure that the mains supply (Voltage, Frequency, & Phase) complies with the rating label.
- The Fan should only be used in conjunction with the appropriate products.
- The fan should only be used in conjunction with fixed wiring.
- When the Fan is used to remove air from a room containing a fuel-burning appliance, ensure that the air replacement is adequate for both the fan and the fuel-burning appliance.
- The Fan should not be used where it is liable to be subject to direct water spray for prolonged periods of time.
- Where ducted Fans are used to handle moisture-laden air, a condensation trap should be fitted in any vertical exhaust ducts. Horizontal ducts should be arranged to slope slightly downwards away from the Fan. Ducts passing through cold voids must be suitably insulated.
- This appliance is not intended for use by persons (including children) with reduced physical, sensory or mental capabilities, or lack of experience and knowledge, unless they have been given supervision or instruction concerning use of the appliance by a person responsible for their safety.
- Young children should be supervised to ensure that they do not play with the appliance.



This product should not be disposed of with household waste. Please recycle where facilities exist. Check with your local authority for recycling advice.

DESCRIPTION

The Centra 100mm fan is a continuously running extract fan for kitchens, utility rooms, bathrooms and toilets. The fan can be wall or panel/ceiling mounted.

A. INSTALLATION

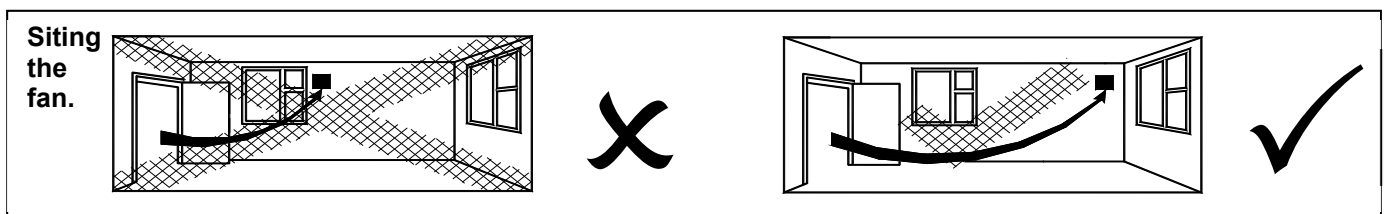

IMPORTANT: The fan should only be used in conjunction with fixed wiring.

PANEL/CEILING MOUNTING

1. For panel/ceiling mounting the fan should be installed into a closed duct system of at least 1.2m long or protected by an exterior air grille that must comply with the standard requirements of your country to prevent access to the fans impeller.
2. Cut a 105mm diameter hole.
3. Loosen the screw at the bottom of the grille and remove the front grille. Mark the screw centres through the holes in the fan back plate. Drill, plug and screw into position.
4. Attach ducting as required for the installation.
5. Wire the fan as described in the Wiring section. Adjust any settings as required (see Setup section).
6. Replace the grille and tighten the retaining screw.
7. After installation, ensure impeller rotates freely.

WALL MOUNTING

1. For wall mounting cut a 115mm diameter hole through the wall and insert the wall sleeve. Slope the sleeve slightly downwards away from the fan. Cut to length and cement both ends into position flush with the wall faces.
2. Loosen the screw in the bottom of the grille and remove the front grille. Mark the screw centres through the holes in the fan back plate. Drill, plug and screw into position.
3. Fix exterior grille into position with the louvres positioned downwards. (Note:- The grille must comply with the standard requirements of your country to prevent access to the fans impeller).
4. Wire the fan as described in Section B-Wiring. Adjust any settings as required (see Section C-Setup).
5. Replace the grille and tighten the retaining screw.
6. After installation, ensure impeller rotates freely.

B. WIRING.



WARNING: THE FAN AND ANCILLARY CONTROL EQUIPMENT MUST BE ISOLATED FROM THE POWER SUPPLY DURING THE INSTALLATION / OR MAINTENANCE.

- The fan should only be used in conjunction with fixed wiring.
 - The cross - sectional area of supply cord used should be ranged from 1 -1.5mm².
 - Cable entry can only be made from the rear of the fan.
 - The extraction fan is suitable for connection to 220-240V 50Hz supply.
 - The fan is a class II double insulated product and **MUST NOT** be earthed.
1. Select and follow the appropriate wiring diagram. **(Fig. 1, 2, 3 & 4)**
 2. Check all connections have been made correctly and ensure all terminal connections and cable clamps are securely fastened.

Fig.1 Continuous trickle with no remote boost facility (T & TP)

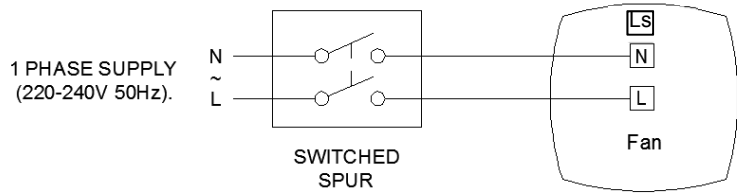
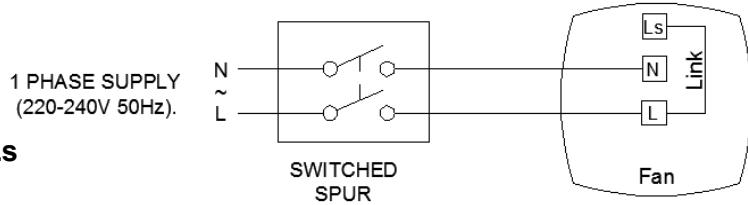

Fig.2 Continuous Boost with no trickle facility (T, TP, HT, HTP)



Note:- Link must be fitted between L & Ls

Fig.3 Continuous trickle with boost facility via integral pullcord (TP & HTP)

Note:- Link must be fitted between N & Ls

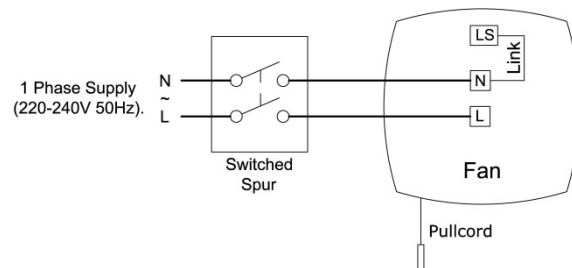
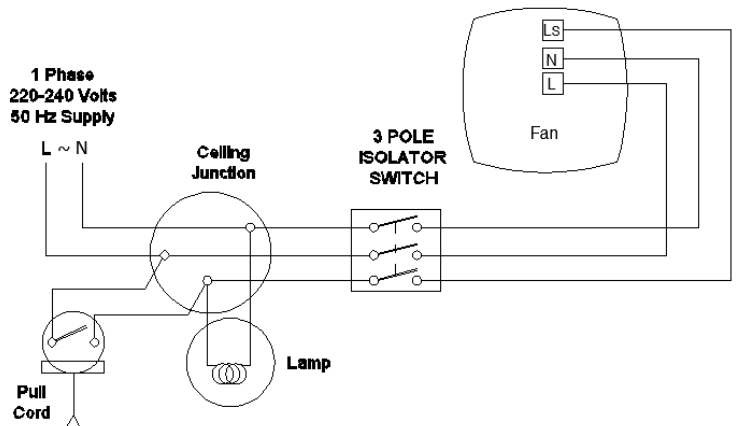

Fig.4 Continuous trickle with boost facility via remote switch. (T, TP, HT & HTP)



C. SETUP



WARNING: THE FAN AND ANCILLARY CONTROL EQUIPMENT MUST BE ISOLATED FROM THE POWER SUPPLY DURING THE INSTALLATION / OR MAINTENANCE.

Accessing the wiring and control settings – (Fig. 5 and 6)

Fig.5.

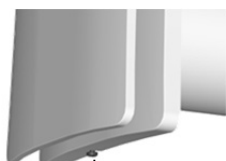

1. Loosen screw.

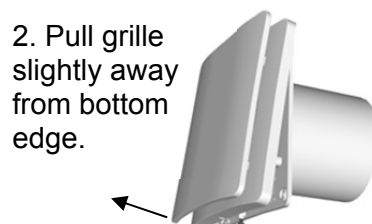

2. Pull grille slightly away from bottom edge.

3. Push grille upwards until clear from the fan chassis.

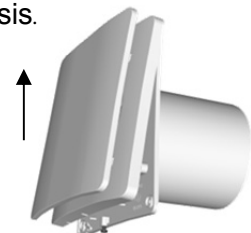

Trickle speed selection (6l/s or 9l/s) – (Fig. 6)

The fan can extract at 6l/s (22m³/h) or 9l/s (32m³/h) flow rate. The fan will boost to 15l/s (54m³/h) when the LS connection is switched.

- Factory set at **6l/s** (22m³/h).
- Remove jumper connector (JP1) if **9l/s** (32m³/h) extract flow rate is required.

BOOST SPEED SELECTION (Fig. 6):

The fan has two boost speed settings for different installation requirements:

- 1) Max speed: Dip switch 2 in the 'OFF' position.



- 2) 15 l/s speed: Dip switch 2 should be in the 'ON' position. (Factory set)



Dip switch 1 should be in the 'ON' position for constant trickle mode or 'OFF' for use as an intermittent fan. In this mode the fan will only run when the pullcord or LS is activated.

Boost Timer Setting

With jumper JP2 removed the fan will enter boost when the LS connection is switched. The fan can continue to boost for 15 minutes after the LS connection is switched off. With jumper JP2 in place there will be no overrun timer, when the LS connection is switched off the fan will leave boost.

Pullcord (TP & HTP):- The integral pullcord activates the timer. The fan will boost for 15(JP2 off) or 5(JP2 on) minutes. If the integral pullcord is pulled for a second time (Once activated), the timer will be cancelled and the fan will revert back to the trickle extract rate. **(Fig.3)**

TIMER ADJUSTMENT (T AND TP MODELS) (FIG. 6)

BEFORE ADJUSTING THE TIMER, SWITCH OFF THE MAINS SUPPLY. TIMER SHOULD ONLY BE ADJUSTED BEFORE OR DURING INSTALLATION.

1. Remove the fan grille. The controller is factory set at 15 minutes approx. The overrun time period can be adjusted from 1-30 minutes by altering the adjuster on the control PCB.
2. To REDUCE the operating time, use a small screwdriver to turn the adjuster **Fig.6. ANTI-CLOCKWISE.**
3. To INCREASE the operating time, use a small screwdriver to turn the adjuster **Fig.6. CLOCKWISE.**
4. Replace the fan grille.

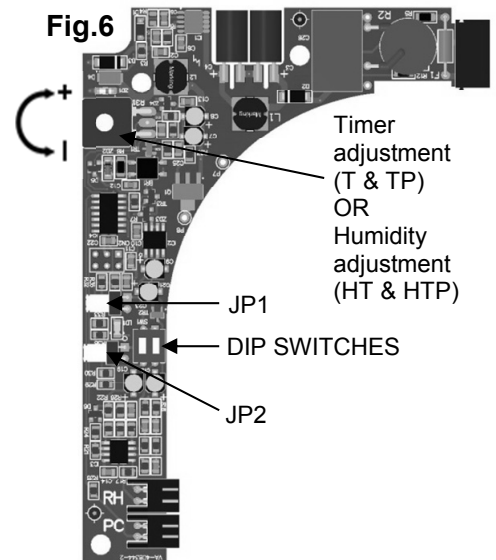

HUMIDITY SET-POINT ADJUSTMENT (HT & HTP) (FIG. 6)

BEFORE ADJUSTING THE CONTROLLER, SWITCH OFF THE MAINS SUPPLY. HUMIDISTAT SHOULD ONLY BE ADJUSTED BEFORE OR DURING INSTALLATION.

1. Remove the fan grille. The controller is factory set to switch on at about 70% RH. The humidity set point can be adjusted from 50-95%RH by altering the adjuster on the control PCB.
2. To LOWER the set-point use a small screwdriver to turn the adjuster **(Fig.6.) ANTI-CLOCKWISE**. This makes the controller MORE sensitive.
3. To RAISE the set-point use a small screwdriver to turn the adjuster **(Fig.6.) CLOCKWISE**. This makes the controller LESS sensitive.
4. Replace the fan grille.

SERVICING AND MAINTENANCE.

**WARNING: THE FAN AND ANCILLARY CONTROL EQUIPMENT
MUST BE ISOLATED FROM THE POWER SUPPLY DURING MAINTENANCE.**

1. At intervals appropriate to the installation, the fan should be inspected and cleaned to ensure there is no build-up of dirt or other deposits.
2. Carefully push the front panel of the grille upwards away from the base part of the grille **(Fig. 5)**.
3. Wipe the inlets and front face with a damp cloth until clean.
The fan has sealed for life bearings, which do not require lubrication.

DATA LOGGER

The fan records the number of days it has been running for. In order to use this feature, power to the fan needs to be switched off and the flat outer grille removed by pushing it upwards. When the fan is switched back on again, after 30 seconds, a blue LED on the electronics control board will light up (See Fig.7 for location). The LED will turn off after 5 seconds; it may then flash a number of times before it comes back on again. Count the number of flashes, if there are no flashes then the number is 0. The number of flashes represents number of thousands of days. This process is repeated 3 more times with the second set being 100s of days, third 10s of days and finally single days. The number of days recorded cannot be reset and will continue to count from the displayed number.

For example, the fan is turned on then after 30 seconds; the first set of flashes counts 1, second set 6, third set there are no flashes and the final set has 9 flashes. This means the fan has run for a total of 1609 days.

Fig. 7

The LED will be visible through the cover here.

The LED will also illuminate when the fan is boosting via LS input.

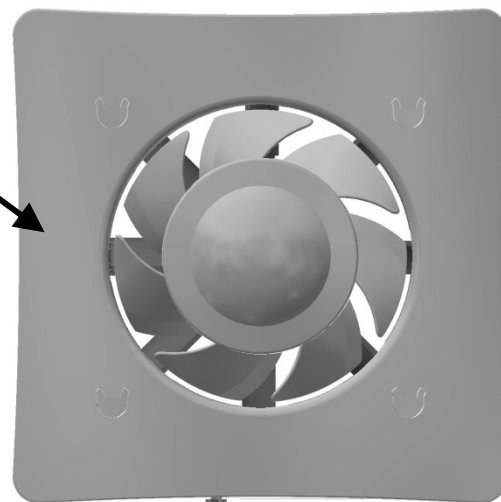

PRODUCT FICHE

For Residential Ventilation Units (Complying Commission Delegated Regulation (EU) No 1254/2014)

Name:	Vent-Axia	Vent-Axia	Vent-Axia	Vent-Axia
Model ID (Stock Ref.) :	Lo-Carbon Centra T - 442954	Lo-Carbon Centra TP - 447127	Lo-Carbon Centra HT - 442955	Lo-Carbon Centra HTP - 443045
SEC Class	E	E	C	C
SEC Value ('Average')	15.72	15.72	26.23	26.23
SEC Value ('Warm')	7.11	7.11	11.86	11.86
SEC Value ('Cold')	30.75	30.75	51.31	51.31
Label Required? (Yes/No=Out of scope)	No	No	No	No
Declared as: RVU or NRUV/UVU or BVU	RVU-UVU	RVU-UVU	RVU-UVU	RVU-UVU
Speed Drive	2-Speed	2-Speed	2-Speed	2-Speed
Type HRS (Recuperative, Regenerative, None)	None	None	None	None
Thermal Eff: [(%), NA(if none)]	N/A	N/A	N/A	N/A
Max. Flow Rate (m3/h)	54.00	54.00	54.00	54.00
Max. Power Input (W): (@Max.Flow Rate)	2.40	2.40	2.40	2.40
LWA: Sound Power Level (dB)	33.02	33.02	33.02	33.02
Ref. Flow Rate (m3/s)	0.01	0.01	0.01	0.01
Ref. Pressure Diff. (Pa)	N/A	N/A	N/A	N/A
SPI [W/(m3/h)]	0.06	0.06	0.06	0.06
Control Factor & Control Typology: (CTRL/ Typology)				
Control Factor; CTRL	0.95	0.95	0.65	0.65
Control Typology	Clock Control	Clock Control	Local Demand Control	Local Demand Control
Declared: -Max Internal & External Leakage Rates(%) for BVUs or carry over (for regenerative heat exchangers only), -&Ext. Leakage Rates (%) for Ducted UVUs;	N/A	N/A	N/A	N/A
Mixing Rate of Non-Ducted BVUs not intended to be equipped with one duct connection on either supply or extract air side;	N/A	N/A	N/A	N/A
Position and description of visual filter warning for RVUs intended for use with filters, including text pointing out the importance of regular filter changes for performance and energy efficiency of the unit	N/A	N/A	N/A	N/A
For UVUs (Instructions Install Regulated Supply/Extract Grilles Façade)	In F&W	In F&W	In F&W	In F&W
Internet Address (for Disassembly Instructions)	www.vent-axia.com	www.vent-axia.com	www.vent-axia.com	www.vent-axia.com
Sensitivity p. Variation@+20/-20 Pa: (for Non-Ducted Vus)	N/A	N/A	N/A	N/A
Air Tightness-ID/OD-(m3/h) (for Non-Ducted Vus)	N/A	N/A	N/A	N/A
Annual Electricity Consumption: AEC (kWh/a)	0.82	0.82	0.52	0.52
Annual Heating Saved: AHS (kWh/a)				
AHS: Average	15.72	15.72	26.23	26.23
AHS: Warm	7.11	7.11	11.86	11.86
AHS: Cold	30.75	30.75	51.31	51.31

The **Vent-Axia** Guarantee

Applicable only to products installed and used in the United Kingdom. For details of guarantee outside the United Kingdom contact your local supplier.

Vent-Axia guarantees its products for two years from date of purchase against faulty material or workmanship. In the event of any part being found to be defective, the product will be repaired, or at the Company's option replaced, without charge, provided that the product:-

- Has been installed and used in accordance with the instructions given with each unit.
- Has not been connected to an unsuitable electricity supply. (The correct electricity supply voltage is shown on the product rating label attached to the unit).
- Has not been subjected to misuse, neglect or damage.
- Has not been modified or repaired by any person not authorised by the company.

IF CLAIMING UNDER TERMS OF GUARANTEE

Please return the complete product, carriage paid to your original supplier or nearest Vent-Axia Centre, by post or personal visit. Please ensure that it is adequately packed and accompanied by a letter clearly marked "Guarantee Claim" stating the nature of the fault and providing evidence of date and source of purchase.

The guarantee is offered to you as an extra benefit, and does not effect your legal rights

Vent-Axia

Head Office: Fleming Way, Crawley, West Sussex, RH10 9YX. Tel: 01293 526062 Fax: 01293 551188

UK NATIONAL CALL CENTRE, Newton Road, Crawley, West Sussex, RH10 9JA

SALES ENQUIRIES: Tel: 0344 8560590 Fax: 01293 565169

TECHNICAL SUPPORT: Tel: 0344 8560594 Fax: 01293 532814

For details of the warranty and returns procedure please refer to www.vent-axia.com or write to Vent-Axia Ltd, Fleming Way, Crawley, RH10 9YX