

# Vent-Axia Minivent™

## Ducted Bath/Shower Fan Kit



### Features and Benefits

- > IP44 rated.
- > Powerful axial in-line fan with downstream airflow guide vanes.
- > Complete kit supplied.
- > Simple installation.
- > Meets **Building Regulation Requirements** for WC's.
- > Integral timer version, set at 15 minute overrun.

## Powerful Axial In-Line Fan

The Vent-Axia Minivent ducted bath/shower kit includes all the components necessary to install a ducted 100mm system in one box. This simplifies fitting of an efficient ventilation system to small rooms, including bath and shower rooms and WC's. It is especially suitable for en-suite bathrooms.

The fan kit has ample performance to meet the **Building Regulations Requirements** for WC's. The timer version should be used for internal rooms.

The kit consists of a Minivent IP44 In-Line fan, a white ceiling grille and spigot, 3 metres\* of flexible duct and an external louvre for soffit or wall mounting. The duct should be

cut to the required length and the bend radius kept to a maximum to provide the best fan performance.

Enclosed terminal compartment, Class 1 earthed appliance.

Supply voltage 220-240/1/50Hz.

### Built-in Controls

#### Timer Model

15 minute overrun timer **complies with Building Regulations Document F**. The timer is triggered by the lighting circuit. Pre-wired for easy installation.

### FAQ's Answered

Roof, wall and soffit termination accessories can be used.

Suitable for use with remote humidistats where required.

To prevent backdraughts fit a Quick fix airflow shutter.

A 15 minute overrun timer version is available (SKT).

Maximum recommended length of ducting: 3 metre (supplied).

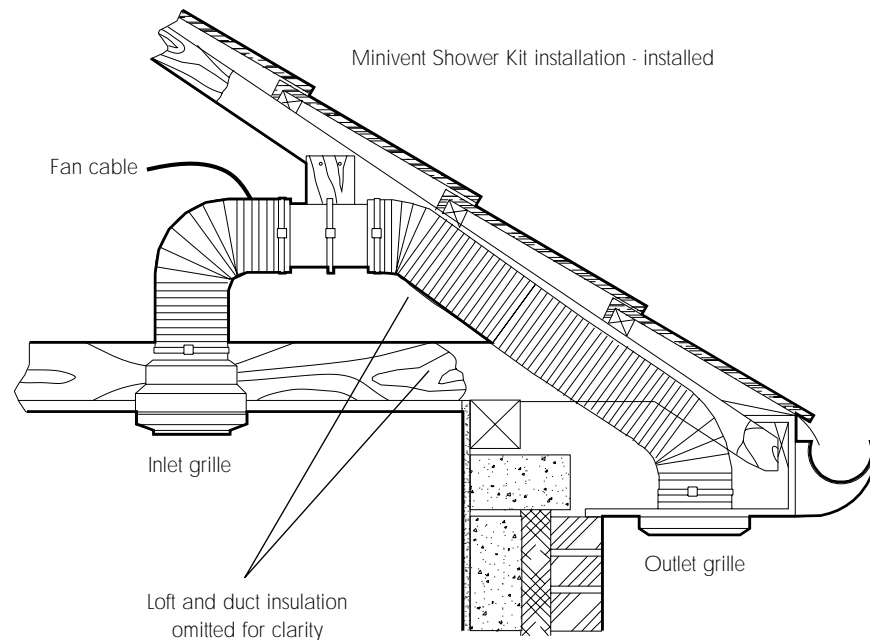

### Typical Specification

Supply and install a Minivent in-line ducted fan kit including white ceiling grille and spigot, 3 meters of flexible ducting and an external louvre as manufactured by Vent-Axia Ltd, Fleming Way, Crawley, West Sussex, RH10 9YX, Telephone: 01293 526062.

When installed the fan performance should meet the Building Regulation (Document F) requirements.

The motor should be manufactured with self aligning sleeve bearings and be fitted with Standard Thermal Overload Protection (S.T.O.P.) the motor should be insulated to Class B.

Operation:  
Minivent SK - via light switch  
Minivent SKT - via light switch with timer overrun facility

### Performance

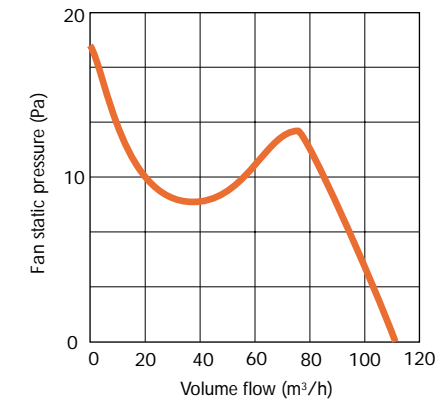

### Dimensions (mm)

	A	ØB	C (Timer)
mm	80	98	115

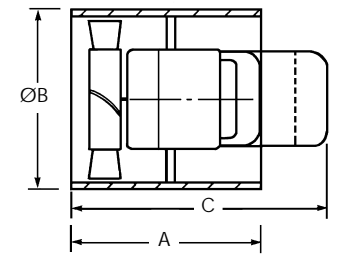
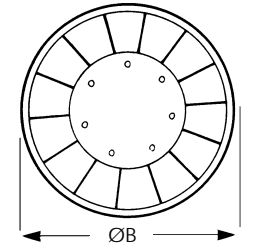

For Wiring Diagrams see pages 225.

### Control

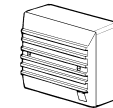

#### Ambient Response Humidity Sensor

An electronic On/Off wall mounted humidistat, which reacts to any rapid increase in both humidity and temperature, switching a Vent-Axia fan 'On' for rapid removal of moisture laden air. Night time RH increment setback feature suppresses nuisance tripping when the humidity level gradually rises as the temperature falls. Stock Ref. No. 56 35 50

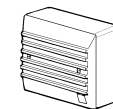

#### Ecotronic Humidity Sensor

Self programming electronic On/Off wall mounted humidity sensor which reacts to any rapid increase in humidity.

Dim. 87 x 87 x 33mm (L x H x D).

Stock Ref. No. 56 35 32

### Accessories

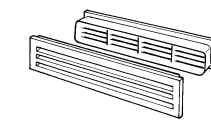

#### Air replacement grille set

For air replacement through doors and panels. Consists of a two piece telescopic set, which fits unobtrusively on either side of the door or panel. Minimum fixing thickness 30mm.

Material: ABS Plastic.

Dimensions: 454 x 90mm.

Size of hole: 435 x 76mm.

Ivory Stock Ref. No. 56 14 01

Brown Stock Ref. No. 56 14 00

Model	Stock Ref. No.	m³/h fid	l/s	Watts	dB(A) @ 3m
VA Minivent SK	24 87 10	110	30	20	37
VA Minivent SKT with timer	24 88 10	110	30	22	37