

Centrifugal Roof Fans (RBH)

Features and Benefits

- **Motors protected to IP44.**
- **Motor insulation Class 'B'.**
- **Maximum operating temperature 40°C.**
- **Standard Thermal Overload Protection.**
- **IP65 service isolator, except on size 250 dia where a service switch is provided**
- **Bird guard.**
- **Speed controllable motors.**
- **Manufacture controlled to BS EN ISO 9001.**
- **Performance tested to BS 848 Part 1 & 2.**
- **2 Year Guarantee.**

Specially designed for use when high pressure characteristics are required. Centrifugal roof models are delivered on-site ready for installation, fully assembled including service isolator. The range consists of 9 sizes with duties from 0.248m³/s to 4.5m³/s (892m³/h to 16200m³/h) with high pressure development available up to 900 Pa making this range particularly suited for ducted applications.

The mounting plate is moulded with an integral fixed bellmouth to ensure optimum efficiency and precise alignment. The weather-cowl is also moulded to produce a smooth internal surface and a tough UV resistant finish. Colour: BS 10A07. Alternative colours available on request. Equally suitable for flat or inclined roofs, backward curve centrifugal roof models are suitable for kerb or purlin box mounting and feature a wide range of accessories for many different industrial applications.

Vent-Axia centrifugal roof fans are designed for either kerb or inclined fixing (max. angle 30°).

Motors

The Centrifugal roof range features a proven external rotor motor and backward curved aluminium impeller assembly selected for performance and non-overloading characteristics. The assembly is dynamically balanced to VDI 2060. The motors in this range are protected to IP44 according to BS EN 60529. Ball bearings are greased for life and are designed to run at any angle. Insulation is Class 'B' (from -30°C to +40°C). Manufacture is controlled to BS EN ISO 9001 standards.

Electrical

Single phase 220-240V Hz. Capacitor start and run. Three phase 380-415V 50Hz. A service isolator switch is provided for local isolation to meet COSHH requirements. The enclosure is protected to IP65 according to BS EN 60529, except on size 250 dia where a service switch is provided.

All motors are fitted with Standard Thermal Overload Protection (S.T.O.P.), which for three phase fans should be wired into all controller circuits and into starter contactors. Most models are available with 4, 6 and 8 pole motors.

Sound Levels

Published dB(A) figures are free field sound pressure levels at 3m with spherical propagation at a reference level of 2 x 10⁻⁵Pa (20 micro-Pascals).

The sound power levels spectra figures are dB with a reference level of 10⁻¹² Watts (1 pico watt).

Centrifugal Roof Fan Accessories

Purlin boxes

Available in sizes to suit all models. Should be used to support the fan in conjunction with a soaker flange sheet.

Roof attenuators

Available in all sizes to cover the range of centrifugal roof fans in three lengths: 600, 900 or 1200mm according to the attenuation required.

Shutters

Robust construction and designed to fit beneath the fan using the fittings provided. Airflow operated, manual or motorisable shutter. A minimum distance of half the attenuator width is required between an airflow shutter and a roof attenuator for satisfactory operation.



Dimensions (mm)

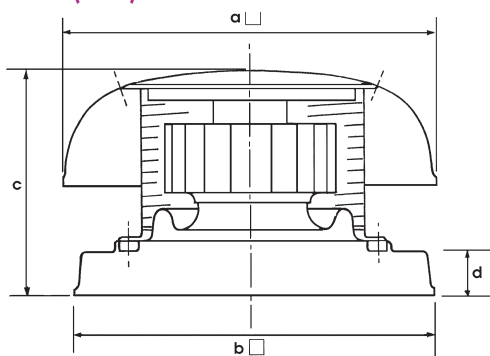

Fan size	a □	b □	c	d	Weight Kg
250	500	500	280	90	16
315/355	700	680	410	83	16/22
400/450	800	780	480	83	24/27
500/560	950	930	575	103	35/46
630/710	1230	1055	630	103	57/73

Details for Purlin Mounting

(Manufactured from 1.5mm pre-galv. mild steel).

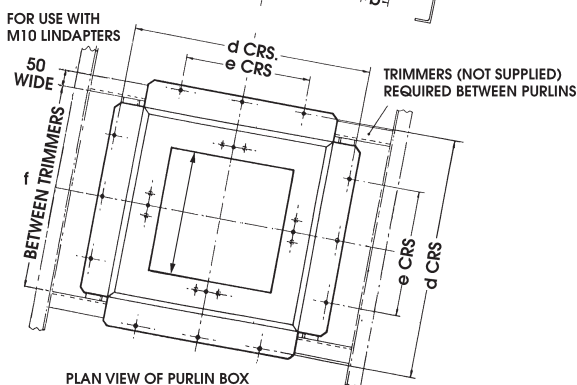
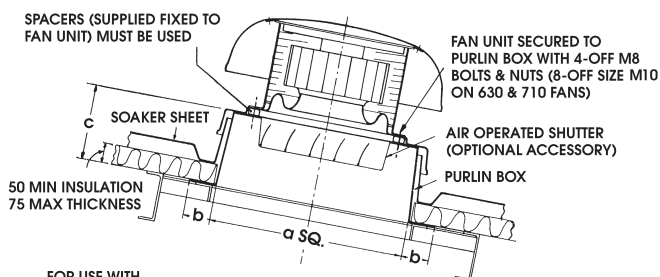

Fan size	a □	b	c	d □	e □	f	g □
315/355	625	90	240	765	400	653	400
400/450	725	90	240	865	500	753	500
500/560	890	70	250	990	650	878	650
630/710	1030	75	250	1140	760	1028	790

Details for Kerb Mounting

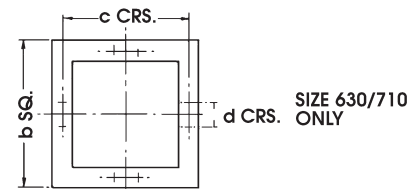
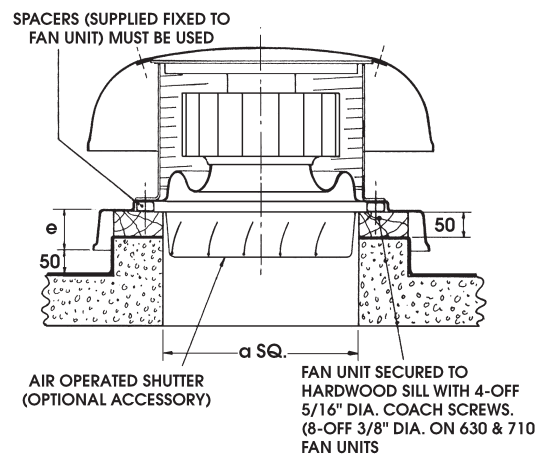

Fan size	a □	b □	c	d	e
250	350	450	400	-	90
315/355	400	600	470	-	83
400/450	500	700	570	-	83
500/560	650	850	690	-	103
630/710	790	990	842	100	103

Centrifugal Roof Fans (RBH)

Performance Curve

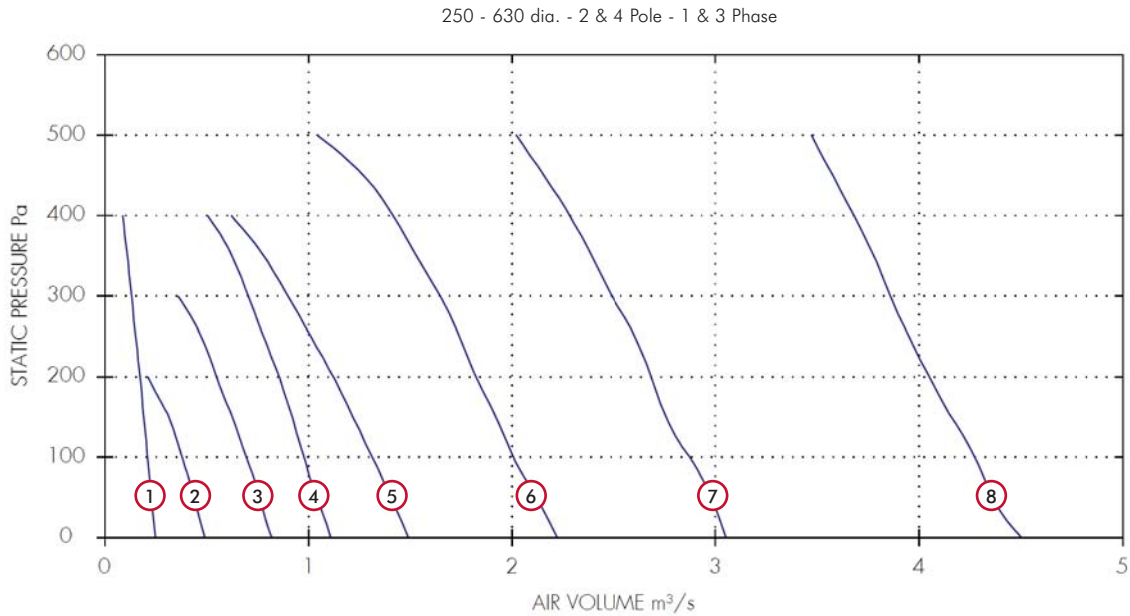

Performance Guide

Dia	Pole	Phase	Stock Motor	Ref. No.	r.p.m.	Curve Ref.	m³/s at Pa								Motor kW	S.C. Amps	F.L.C. Amps	dBA @ 3m	
							0	50	100	150	200	250	300	350					400
250	2	1	RBH250-12	2720	①	0.248	0.229	0.211	0.192	0.174	0.152	0.132	0.111	0.088	0.16	2.1	0.7	62	
315	4	1	RBH31514	1400	②	0.493	0.439	0.381	0.314	0.21					0.17	1.4	0.8	52	
355	4	1	RBH35514	1425	③	0.819	0.761	0.694	0.625	0.55	0.475	0.36			0.34	4	1.54	55	
400	4	1	RBH40014	1420	④	1.111	1.04	0.978	0.92	0.856	0.78	0.705	0.625	0.503	0.55	5.9	2.3	57	
400	4	3	RBH40034	1420	④	1.111	1.04	0.978	0.92	0.856	0.78	0.705	0.625	0.503	0.43	2.3	0.78	57	
450	4	1	RBH45014	1380	⑤	1.491	1.405	1.314	1.22	1.122	1.011	0.9	0.78	0.62	0.76	6.8	3.1	61	
450	4	3	RBH45034	1380	⑤	1.491	1.405	1.314	1.22	1.122	1.011	0.9	0.78	0.62	0.64	3.7	1.3	61	
500	4	1	RBH50014	1435	⑥	2.222	2.121	2.006	1.92	1.822	1.742	1.647	1.53	1.417	1.04	1.25	22	5.5	65
500	4	3	RBH50034	1435	⑥	2.222	2.121	2.006	1.92	1.822	1.742	1.647	1.53	1.417	1.04	1.25	11	2.3	65
560	4	3	RBH56034	1415	⑦	3.054	2.981	2.875	2.758	2.686	2.606	2.491	2.392	2.283	2.019	1.9	16.8	3.5	67
630	4	3	RBH63034	1465	⑧	4.504	4.361	4.275	4.16	4.05	3.95	3.86	3.778	3.681	3.472	3.7	46	6.5	72

Sound Power Level Spectra dB (re 10⁻¹²Watts)

Dia	Pole	63	125	250	500	1k	2k	4k	8k
250	2	69	75	80	78	76	74	73	66
315	4	64	75	77	70	60	63	63	51
355	4	65	79	80	74	64	65	67	53
400	4	69	84	82	77	66	69	71	59
450	4	71	86	86	80	70	72	72	62
500	4	74	91	90	82	74	74	81	68
560	4	77	94	93	83	78	77	85	69
630	4	81	99	99	87	84	81	85	84

Performance Curve

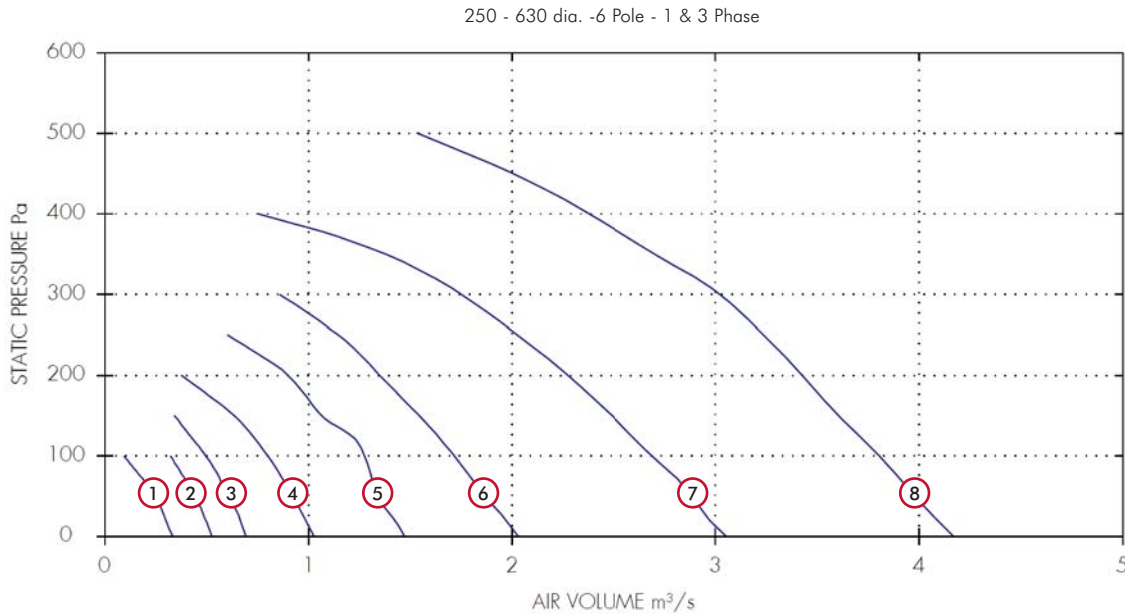

Performance Guide

Dia	Pole	Phase	Stock Motor Ref. No.	r.p.m.	Curve Ref.	m³/s at Pa										Motor kW	S.C. Amps	F.L.C. Amps	dBA @ 3m	
						0	50	100	150	200	250	300	350	400	500					
315	6	1	RBH31516	945	①	0.333	0.251	0.094									0.08	0.75	0.39	43
355	6	1	RBH35516	910	②	0.528	0.444	0.323									0.15	1.2	0.56	44
400	6	1	RBH40016	925	③	0.694	0.61	0.497	0.34								0.17	2.1	0.75	49
400	6	3	RBH40036	925	③	0.694	0.61	0.497	0.34								0.17	1	0.41	49
450	6	1	RBH45016	930	④	1.029	0.924	0.8	0.635	0.376							0.3	2	1.5	52
450	6	3	RBH45036	930	④	1.029	0.924	0.8	0.635	0.376							0.22	1.1	0.46	52
500	6	1	RBH50016	945	⑤	1.472	1.342	1.213	1.064	0.9	0.602						0.45	4.2	2.1	55
500	6	3	RBH50036	945	⑤	1.472	1.342	1.213	1.064	0.9	0.602						0.4	1.65	0.86	55
560	6	3	RBH56036	945	⑥	2.028	1.869	1.717	1.544	1.35	1.145	0.858					0.69	2.9	1.5	58
630	6	3	RBH63036	945	⑦	3.054	2.885	2.69	2.49	2.275	2.025	1.75	1.375	0.75			1.2	17	2.7	61
710	6	3	RBH71036	975	⑧	4.168	3.98	3.808	3.604	3.428	3.239	3.022	2.7	2.38	1.533	2.01	27	3.6	64	

Sound Power Level Spectra dB (re 10⁻¹²Watts)

Dia	Pole	63	125	250	500	1k	2k	4k	8k
315	6	61	62	65	58	52	58	50	36
355	6	63	67	67	63	55	62	50	39
400	6	70	78	72	66	58	66	59	49
450	6	73	79	75	70	62	65	60	50
500	6	73	81	81	71	64	67	71	51
560	6	78	86	84	73	68	72	72	54
630	6	80	87	88	73	71	71	70	58
710	6	82	87	87	77	75	78	79	65

Centrifugal Roof Fans (RBH)

Performance Curve

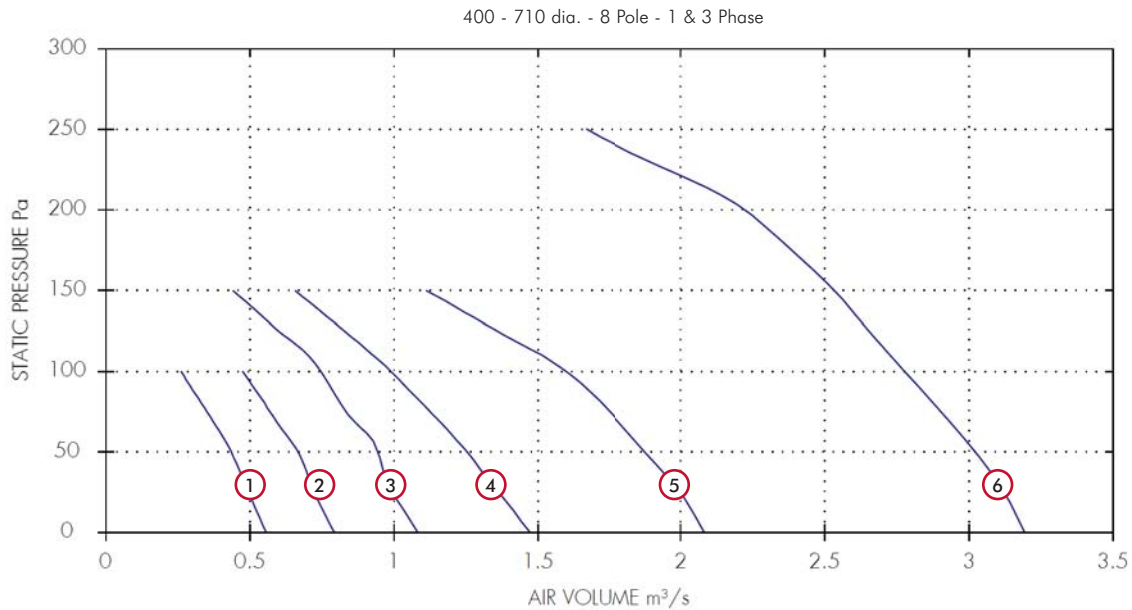

Performance Guide

Dia	Pole	Phase	Stock Motor Ref. No.	r.p.m.	Curve Ref.	m ³ /s at Pa						Motor kW	S.C. Amps	F.L.C. Amps	dBA @ 3m	
						0	25	50	100	150	200					250
400	8	1	RBH40018	675	①	0.556	0.496	0.436	0.261				0.13	1	0.68	37
400	8	3	RBH40038	675	①	0.556	0.496	0.436	0.261				0.09	0.5	0.26	37
450	8	1	RBH45018	695	②	0.792	0.724	0.667	0.475				0.15	1	0.63	44
450	8	3	RBH45038	695	②	0.792	0.724	0.667	0.475				0.12	0.55	0.27	44
500	8	1	RBH50018	705	③	1.083	0.992	0.913	0.747	0.44			0.23	2.05	1.14	49
500	8	3	RBH50038	705	③	1.083	0.992	0.913	0.747	0.44			0.18	1.1	0.45	49
560	8	3	RBH56038	690	④	1.472	1.364	1.253	0.989	0.656			0.3	1.48	0.61	50
630	8	3	RBH63038	650	⑤	2.083	2	1.875	1.597	1.111			0.43	4.1	1.1	50
710	8	3	RBH71038	710	⑥	3.194	3.122	3.022	2.778	2.533	2.222	1.667	0.93	15	2.1	57

Sound Power Level Spectra dB (re 10⁻¹²Watts)

Dia	Pole	63	125	250	500	1k	2k	4k	8k
400	8	64	66	61	56	65	60	47	43
450	8	69	68	65	62	59	61	46	39
500	8	76	73	71	65	58	67	55	41
560	8	76	75	72	65	62	67	56	46
630	8	78	77	74	63	63	62	59	45
710	8	86	81	78	70	70	73	62	56

Roof Attenuator, Insertion Losses

Attenuator Length 600mm

Impeller Ø	Stock Ref. No.								
		63	125	250	500	1k	2k	4k	8k
315/355	105 20 315	2	4	9	16	20	22	18	14
400/450	105 20 400	2	4	8	15	18	20	17	13
500/560	105 20 500	2	4	9	16	20	22	18	14
630/710	105 20 630	2	4	8	15	18	20	17	13

Attenuator Length 900mm

Impeller Ø	Stock Ref. No.								
		63	125	250	500	1k	2k	4k	8k
315/355	105 21 315	3	6	13	22	30	31	22	17
400/450	105 21 400	2	6	12	20	25	27	20	16
500/560	105 21 500	3	6	13	22	30	31	22	17
630/710	105 21 630	2	6	12	20	25	27	20	16

Attenuator Length 1200mm

Impeller Ø	Stock Ref. No.								
		63	125	250	500	1k	2k	4k	8k
315/355	105 22 315	4	9	16	28	34	35	23	19
400/450	105 22 400	4	8	15	26	32	33	21	18
500/560	105 22 500	4	9	16	28	34	35	23	19
630/710	105 22 630	4	8	15	26	32	33	21	18

Centrifugal Roof Fans (RBH)

Accessories Dimensions (mm)

Roof Attenuator

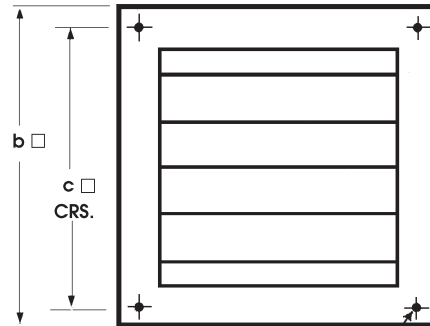
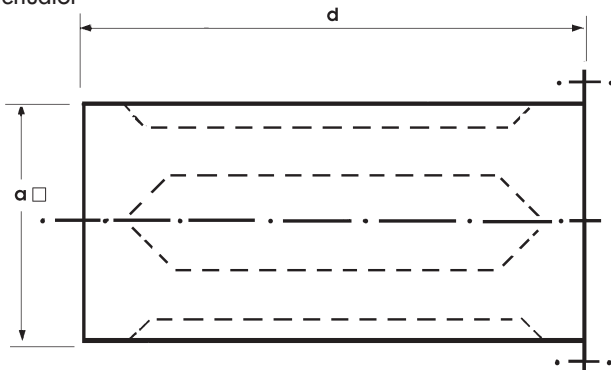

4-HOLES 11.0 DIA.

Stock Ref. No.	a □	b □	c □	d	Kg approx	Area m ²	Resistance curve
10520315	395	495	445	600	18	0.156	②
10520400	495	595	545	600	22	0.245	①
10520500	645	745	695	600	31	0.416	①
10520630	785	885	835	600	44	0.616	③
10521315	395	495	445	900	21	0.156	②
10521400	495	595	545	900	28	0.245	①
10521500	645	745	695	900	39	0.416	①
10521630	785	885	835	900	52	0.616	③
10521315	395	495	445	1200	25	0.156	②
10522400	495	595	545	1200	35	0.245	①
10522500	645	745	695	1200	48	0.416	①
10522630	785	885	835	1200	61	0.616	③

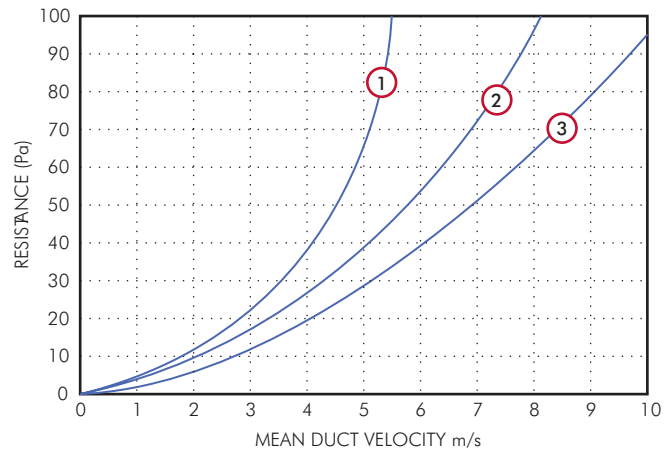

Air Operated Shutters

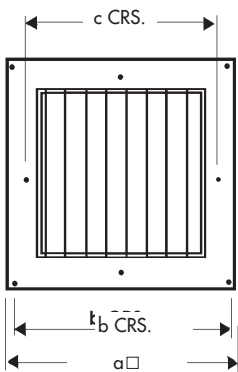

Fan Model	Percentage reduction in performance at 4 Pole speeds
RBH 315	10%
RBH 355	19%
RBH 400	6%
RBH 450	17%

For 6 pole fans, reduce percentages by ratio of fan speeds.

When air operated shutters are used in conjunction with roof attenuators, there must be a minimum spacing of half the attenuator width between them.

Stock Ref. No.	a □	b	c	d
10517315	600	560	470	105
10517400	700	670	570	105

Note:
When shutters are fitted the max. temperature permissible is limited to 40°C

Accessories

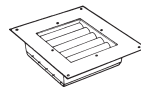
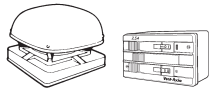

Manual/
motorisable



Stock Ref.	Electronic controller Stock Ref.	*eDemand Controller			Auto transformer Stock Ref.	Air operated Shutters † Stock Ref.	Manual/ motorisable shutter Stock Ref.	600mm † Stock Ref.	Roof attenuators			Purlin boxes Stock Ref.
		Voltage Control Stock Ref.	1/3 Phase Inverter Stock Ref.	3 Phase Inverter Stock Ref.					900mm † Stock Ref.	1200mm † Stock Ref.		
RBH25012	W10303102M	444164	-	-	10314103	-	-	-	-	-	-	-
RBH31514	W10303102M	444164	-	-	10314103	10517315	10518315	10520315	10521315	10522315	10516315	10516315
RBH35514	W10303102M	444164	-	-	10314103	10517315	10518315	10520315	10521315	10522315	10516315	10516315
RBH40014	10303103A	444164	-	-	10314103	10517400	10518400	10520400	10521400	10522400	10516400	10516400
RBH40034	-	444164	-	-	10314301	10517400	10518400	10520400	10521400	10522400	10516400	10516400
RBH45014	10303106A	444164	-	-	10314105	10517400	10518400	10520400	10521400	10522400	10516400	10516400
RBH45034	-	444164	-	-	10314304	10517400	10518400	10520400	10521400	10522400	10516400	10516400
RBH50014	10303110A	444164	-	-	10314107	-	10518500	10520500	10521500	10522500	10516500	10516500
RBH50034	-	444166	444177	444172	10314304	-	10518500	10520500	10521500	10522500	10516500	10516500
RBH56034	-	444166	444177	444172	10314304	-	10518500	10520500	10521500	10522500	10516500	10516500
RBH63034	-	444166	444177	444172	10314311	-	10518630	10520630	10521630	10522630	10516630	10516630
RBH31516	W10303102M	444164	-	-	10314103	10517315	10518315	10520315	10521315	10522315	10516315	10516315
RBH35516	W10303102M	444164	-	-	10314103	10517315	10518315	10520315	10521315	10522315	10516315	10516315
RBH40016	W10303102M	444164	-	-	10314103	10517400	10518400	10520400	10521400	10522400	10516400	10516400
RBH40036	-	444166	444177	444172	10314301	10517400	10518400	10520400	10521400	10522400	10516400	10516400
RBH45016	W10303102M	444166	444177	444172	10314103	10517400	10518400	10520500	10521500	10522500	10516400	10516400
RBH45036	-	444166	444177	444172	10314301	10517400	10518400	10520500	10521500	10522500	1051640	1051640
RBH50016	W10303102M	444165	-	-	10314103	-	10518500	10520500	10521500	10522500	10516500	10516500
RBH50036	-	444164	-	-	10314301	-	10518500	10520500	10521500	10522500	10516500	10516500
RBH56036	-	444164	-	-	10314304	-	10518500	10520500	10521500	10522500	10516500	10516500
RBH63036	-	444166	444177	444173	10314304	-	10518630	10520630	10521630	10522630	10516630	10516630
RBH71036	-	444166	444177	444172	10314307	-	10518630	10520630	10521630	10522630	10516630	10516630
RBH40018	W10303102M	444166	444177	444172	10314103	10517400	10518400	10520400	10521400	10522400	10516400	10516400
RBH40038	-	444166	444177	444173	10314301	10517400	10518400	10520400	10521400	10522400	10516400	10516400
RBH45018	W10303102M	444166	444177	444172	10314103	10517400	10518400	10520500	10521500	10522500	10516400	10516400
RBH45038	-	444166	444177	444172	10314301	10517400	10518400	10520500	10521500	10522500	10516400	10516400
RBH50018	W10303102M	444167	-	444174	10314103	-	10518500	10520500	10521500	10522500	10516500	10516500
RBH50038	-	444166	444177	444173	10314301	-	10518500	10520500	10521500	10522500	10516500	10516500
RBH56038	-	444166	444177	444172	10314301	-	10518500	10520500	10521500	10522500	10516500	10516500
RBH63038	-	444166	444177	444173	10314301	-	10518630	10520630	10521630	10522630	10516630	10516630
RBH71038	-	444166	444177	444172	10314304	-	10518630	10520630	10521630	10522630	10516630	10516630

† Air operated shutters and manual/motorisable shutters are not suitable for use in combination with roof attenuators. Special manual/motorisable shutters can be fitted to the bottom of the roof attenuator. Supplied by others.

* For full range of speed controller options, see Accessories & Controllers Section