

Bifurcated Axial Flow Fume Handling Units (BIF)

Features and Benefits

- Manufactured from UV stabilised polypropylene
- Motor mounted outside the airstream
- Suitable for extracting aggressive corrosive air
- Internal or external mounting
- Quality Assurance to BS EN ISO 9001
- Performance tested to BS 848 Part 1

A range of axial flow bifurcated fans designed to complement the centrifugal fume handling units we offer, and withstand the rigours of fume extraction systems. Features high performance axial flow fans and powerful high quality motors built to withstand hostile environments.

Specification

Casings

The fan casing is constructed in heavy gauge polypropylene UV stabilised with the bore

specially engineered to provide a tight clearance fit. It is complete with drilled flanges at each end to which, either ducting can be directly connected (adequately supported) or, matching flanges with flexible connectors.

Motor and Impeller

A high performance aerofoil section axial-flow impeller in durable polypropylene statically and dynamically balanced. Driven through an extension shaft by a totally enclosed, fan cooled single speed motor to BS 5000/99 out of the airstream and is wound to suit standard UK voltages all complete with terminal box (and capacitor on single phase types).

Electrical

The BIF range is available for either single phase 220-240V 50 Hz capacitor start and run or three phase 380-415V 50Hz.

Terminal Box

An IP54 terminal box is supplied with all models with 20mm and PGII entry offering protection against dust and water jets from any angle.

Performance

The fan performance, is in accordance with tests to BS848 Part 1.

Sound Levels

Fan sound levels, measured in a reverberant chamber in accordance with BS 848 Part 2. Published dB(A) figures are free field sound pressure levels at 3m with spherical propagation at a reference level of 2×10^{-5} Pa (20 micro-Pascal). The sound power level spectra figures are dB with a reference level of 10^{-12} Watts (1 pico-watt). To ensure minimum noise levels during speed control, an auto transformer speed control is recommended.

Accessories

A full range of accessories is available with the Fume Handling Bifurcated Fans:

- D.O.L. Starters
- Flexible Connections
- Mounting Feet
- Coupling Flanges
- Anti-Vibration Mounts
- Attenuators

Accessories

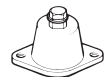
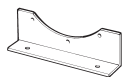
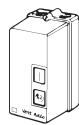
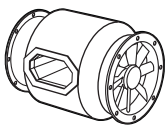

D.O.L.

Mounting Feet

Matching

Flexible

Set of Mounting

Starter & Coil

(Pair)

Flange

Connections

Feet & AV's (4)

Stock Ref. No.

Stock Ref. No.

Stock Ref. No.

Stock Ref. No.

Stock Ref. No.

Stock Ref. No.

BIF250/4/1	444744+444700	BIF250FT	BIFMF250	BIF250FC	AVM220
BIF250/2/3	444744+444701	BIF250FT	BIFMF250	BIF250FC	AVM220
BIF315/4/1	444744+444702	BIF315FT	BIFMF315	BIF315FC	AVM220
BIF315/4/3	444747+444700	BIF315FT	BIFMF315	BIF315FC	AVM220
BIF315/2/3	444747+444700	BIF315FT	BIFMF315	BIF315FC	AVM220
BIF400/4/1	444747+444700	BIF400FT	BIFMF400	BIF400FC	AVM220
BIF400/4/3	444747+444700	BIF400FT	BIFMF400	BIF400FC	AVM220

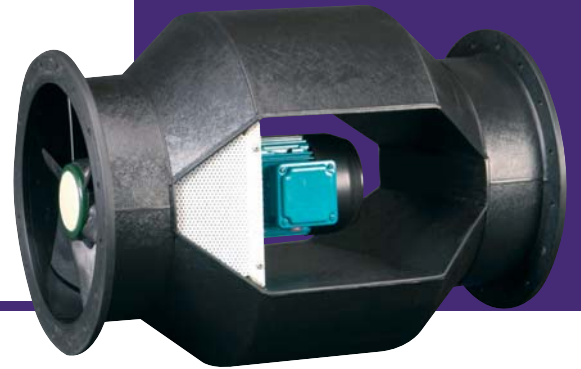

Performance Curve

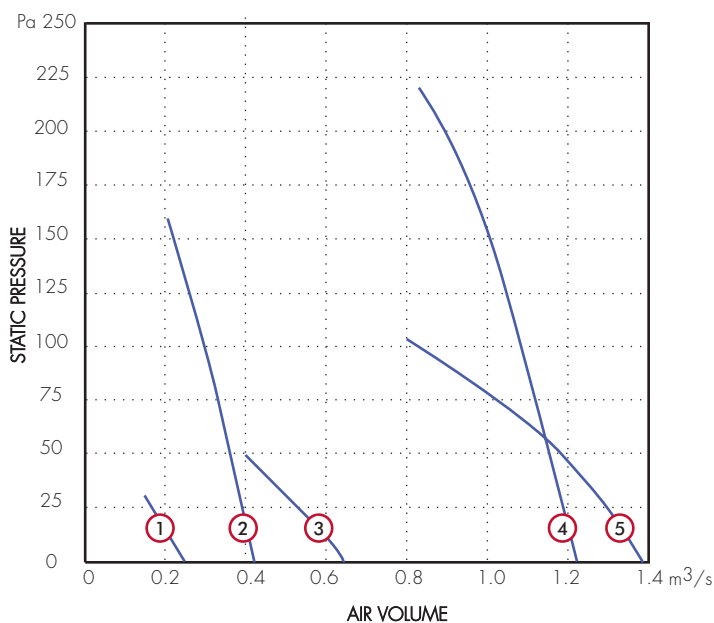

Dimensions (mm)

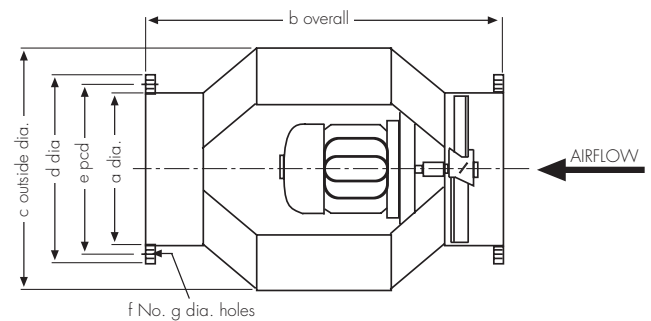

Size	a	b	c	d	e	f	g
250	250	600	400	325	290	8 off	8
315	315	650	480	400	360	16 off	9
400	400	800	620	500	455	16 off	9

Ancillaries: Flexible connectors, AV's, mounting feet and silencers are available

Performance Guide

Stock Ref. No.	Phase Motor	r.p.m	Curve Ref.	FID	m³/s at Pa						kW	Amps	S.C Amps	F.L.C. dBA @ 3m
					25	50	75	100	150	200				
BIF250/4/1	1	1400	①	0.235	0.172	-	-	-	-	-	0.18	7	1.35	49
BIF250/2/3	3	2800	②	0.47	0.442	0.404	0.376	0.338	0.244	-	0.37	4	0.93	67
BIF315/4/1	1	1400	③	0.635	0.545	0.432	-	-	-	-	0.25	10	1.9	55
BIF315/4/3	3	1400	③	0.635	0.545	0.432	-	-	-	-	0.37	4.73	1.2	55
BIF315/2/3	3	2800	④	1.222	1.208	1.175	1.152	1.109	0.997	0.87	0.55	6.6	1.32	71
BIF400/4/1	1	1400	⑤	1.363	1.269	1.157	1.015	0.804	-	-	0.37	14	2.7	61
BIF400/4/3	3	1400	⑤	1.363	1.269	1.157	1.015	0.804	-	-	0.37	4.73	1.2	61

Sound Power Level Spectra db (ref 10-12) Watts

Stock Ref No.	63	125	250	500	1k	2k	4k	8k
BIF250/4	66	67	66	65	65	62	58	54
BIF250/2	81	82	81	80	80	77	73	69
BIF315/4	72	74	73	72	71	68	64	61
BIF315/2	87	89	93	87	86	83	79	76
BIF400/4	76	77	80	75	75	72	68	64

Electrical Supply: Single phase motors are wound for 220-240V/50Hz/1ph AC supply and 3 phase motors are wound for 380-415V/50Hz/3ph AC supply.

NB. Motors must have overload protection and 3 phase motors should also have single phasing prevention.