

Access Rectangular In-Line Fans (ARH)

Features and Benefits

- Motors protected to IP44
- Motor insulation Class 'B'
- Standard Thermal Overload Protection
- IP54 terminal box
- Backward curved centrifugal impeller
- Access panel for ease of maintenance
- MEZ flanging
- Manufacture controlled to BS EN ISO 9001
- Performance tested to BS 848 Parts 1 & 2
- 2 Year Guarantee

The ACCESS range of rectangular backward curved in-line fans have been specifically designed with the latest COSHH (Control of Substances Hazardous to Health) regulations in mind.

These regulations make it a requirement for employers to provide effective methods to control exposure to certain hazardous materials and substances in the work place utilising general or local exhaust ventilation systems. The regulations also require that the system installed be inspected and maintained on a regular and documented basis.

ACCESS has been developed for commercial and industrial applications with the emphasis on fast installation, reliable performance and access for inspection. It features a new generation of backward curved fans specially selected for their performance and non overloading characteristics.

This range of rectangular fans are available with matched accessories for complete ventilation systems in a variety of ducted applications. The innovative and compact design of the galvanised steel casing, backward curved impeller and motor unit ensures that the ACCESS model occupies no more space than ordinary forward curved units.

An access panel on all models comes complete with the motor and impeller assembly mounted on it making maintenance a swift and simple procedure.

Motors/Impeller

The range is powered by a proven external rotor motor and impeller assembly dynamically balanced for quiet, vibration free performance. Motors are rated IP44 according to BS EN 60529. Bearings are greased for life and are designed to run at any angle. Motor insulation is Class 'B'. 100 to 315 dia. operating temperatures 50°C; 355 to 710 dia 40°C.

Manufacture of the motor impellers, casings and assembly are all controlled to BS EN ISO 9001 standards.

The motor/impeller assemblies are dynamically balanced to VDI 2060

Electrical

Single phase 220-240V 50 Hz. Capacitor start and run. The capacitors are located in the terminal box where possible. Three phase 380-415V 50 Hz.

The terminal box on models 355 to 710 are protected to IP54 according to BS EN 60529. All motors are fitted with Standard Thermal Overload Protection (S.T.O.P.), which should be wired into all controller circuits and into starter contactors. Models are available with 2, 4, 6 and 8 pole motors.

Performance

Tested to BS 848 Parts 1 & 2. Published dB(A) figures are free field sound pressure levels at 3m with spherical propagation at a reference level of 2×10^{-5} Pa (20 micro-Pascals). The inlet and outlet sound power level spectra figures are dB with a reference of 10^{-12} Watts (1 pico-watt).

Accessories

Rectangular flexible connections, attenuators and bag filter cassettes.



Fan Dimensions (mm)

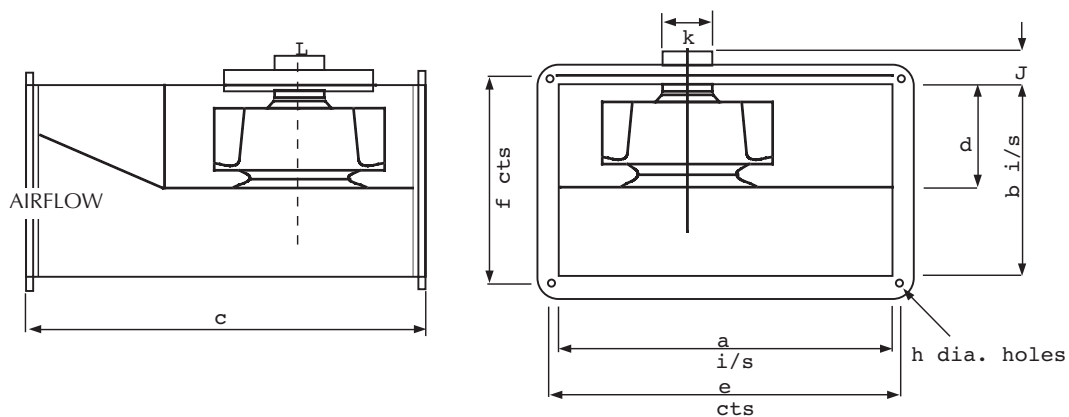

Size	a	b	c	d	e	f	g	h	i	j	k x l	Weight kg	Flange Type
355	550	485	700	260	585	520	35	11	50	160 x 130	40	Ductmate 35	
400	625	535	775	295	660	570	35	11	50	230 x 230	55	Ductmate 35	
450	700	600	850	325	735	635	35	11	65	230 x 230	62	Ductmate 35	
500	775	700	925	355	810	735	35	11	50	230 x 230	80	Ductmate 35	
630	850	800	1000	400	885	835	35	11	55	230 x 230	97	Ductmate 35	
710	950	850	1100	430	985	885	35	11	55	230 x 230	112	Ductmate 35	

Accessories Dimensions (mm)

Rectangular Flexible Connectors

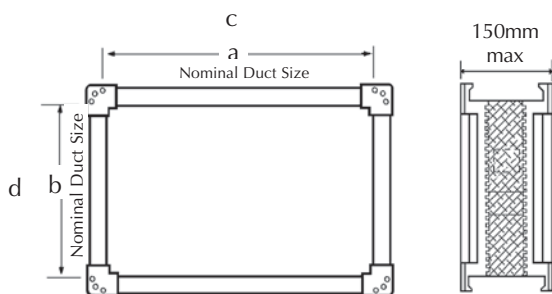

Stock Ref.	a	b	c	d	Flange Type
LFC355	550	485	620	555	Ductmate 35
LFC400	625	535	695	605	Ductmate 35
LFC450	700	600	770	670	Ductmate 35
LFC500	775	700	845	770	Ductmate 35
LFC630	850	800	920	870	Ductmate 35
LFC710	950	850	1020	920	Ductmate 35

Access Rectangular In-Line Fans (ARH)

Performance Curve

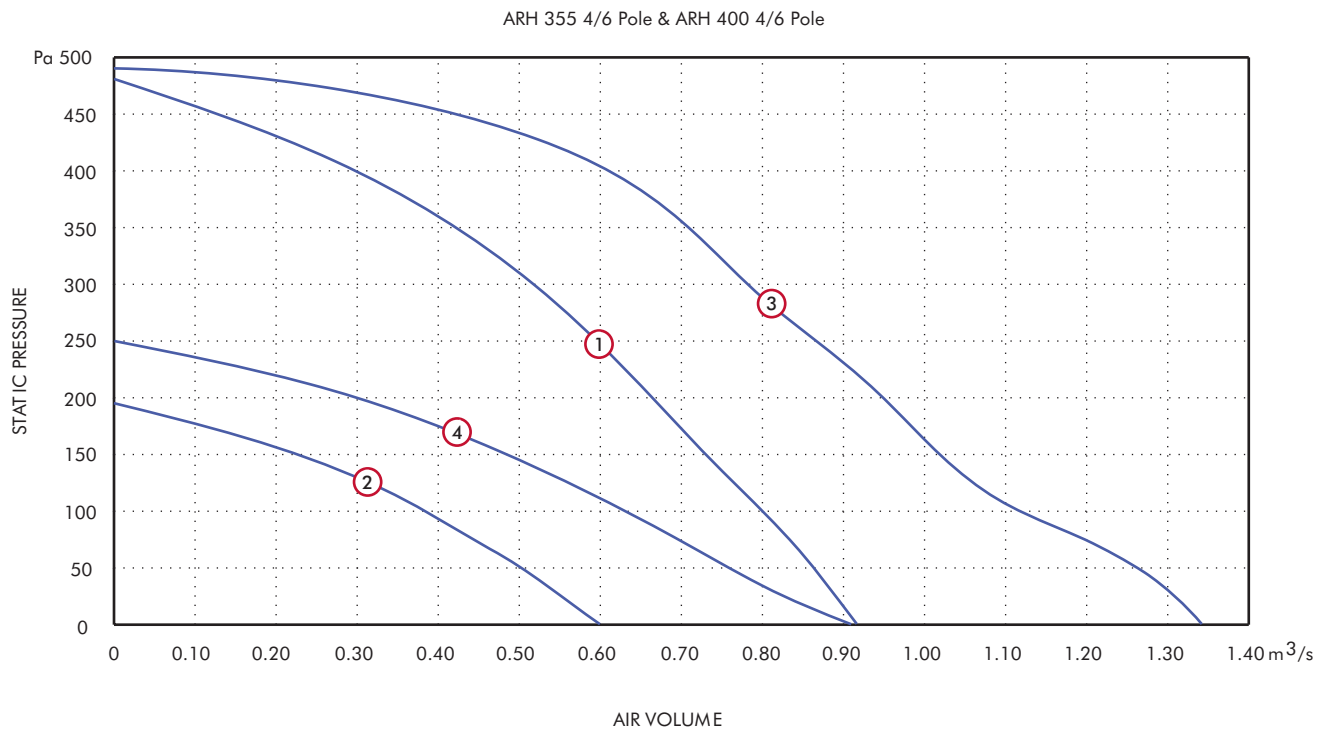

Performance Guide

Duct Size		Stock		Curve											Motor	S.C.	F.L.C.	dBA
W x H	Phase	Pole	Ref. No.	r.p.m.	Ref.	0	50	100	150	200	250	300	350	400	kW	Amps	Amps	@ 3m
550 x 485	1	4	ARH355-14A	1365	①	0.915	0.865	0.803	0.733	0.676	0.596	0.517	0.41	0.3	0.52	5	2.2	59
550 x 485	3	4	ARH355-34A	1365	①	0.915	0.865	0.803	0.733	0.676	0.596	0.517	0.41	0.3	0.46	2.9	0.46	59
550 x 485	1	6	ARH355-16A	880	②	0.6	0.51	0.38							0.17	1.6	0.8	47
550 x 485	3	6	ARH355-36A	880	②	0.6	0.51	0.38							0.16	1.05	0.36	47
625 x 535	1	4	ARH400-14A	1280	③	1.37	1.255	1.14	1.05	0.98	0.885	0.79	0.7	0.6	0.74	7	3.2	61
625 x 535	3	4	ARH400-34A	1280	③	1.37	1.255	1.14	1.05	0.98	0.885	0.79	0.7	0.6	0.69	3.4	1.3	61
625 x 535	1	6	ARH400-16A	840	④	0.91	0.76	0.62	0.49	0.3					0.3	2	1.5	52
625 x 535	3	6	ARH400-36A	840	④	0.91	0.76	0.62	0.49	0.3					0.26	1.1	0.49	52

Sound Power Level Spectra dB (re 10⁻¹² Watts)

Stock Ref	Pole	63	125	250	500	1k	2k	4k	8k	
ARH355	IN DUCT	4	66	84	78	79	75	71	66	59
ARH355	IN DUCT	6	70	69	67	65	63	60	53	46
ARH400	IN DUCT	4	74	91	83	81	76	72	69	65
ARH400	IN DUCT	6	75	86	74	71	67	65	58	48

Performance Curve

ARH 450 4/6 Pole & ARH 500 4/6 Pole

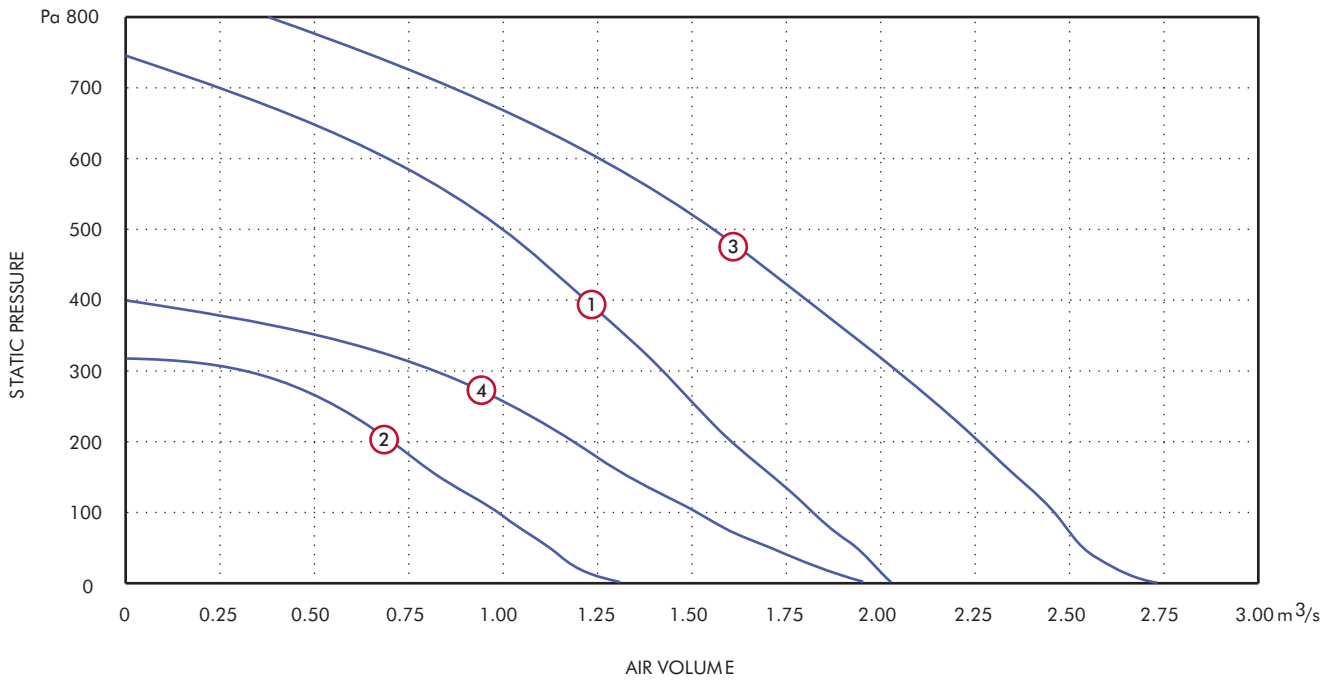

Performance Guide

Duct Size		Stock		Curve											Motor	S.C.	F.L.C.	dBA	
W x H	Phase	Pole	Ref. No.	r.p.m.	Ref.	0	25	50	100	150	200	250	300	350	400	kW	Amps	Amps	@ 3m
700 x 600	1	4	ARH450-14A	1320	①	2.03	1.97	1.74	1.8	1.7	1.6	1.5	1.4	1.312	1.225	1.3	15	5.7	66
700 x 600	3	4	ARH450-34A	1320	①	2.03	1.97	1.74	1.8	1.7	1.6	1.5	1.4	1.312	1.225	1.25	9.2	2.3	66
700 x 600	1	6	ARH450-16A	850	②	1.3	1.21	1.17	1	0.87	0.7					0.45	4.2	2.2	53
700 x 600	3	6	ARH450-36A	850	②	1.3	1.21	1.17	1	0.87	0.7					0.39	1.75	0.81	53
775 x 700	3	4	ARH500-34A	1230	③	2.75	2.61	2.56	2.46	2.3	2.26	2.145	2.03	1.93	1.82	1.8	10	3.4	67
775 x 700	3	6	ARH500-36A	865	④	1.92	1.84	1.72	1.55	1.37	1.19	0.81				0.69	3.6	1.5	55

Sound Power Level Spectra dB (re 10⁻¹² Watts)

Stock Ref	Pole	63	125	250	500	1k	2k	4k	8k	
ARH450	IN DUCT	4	76	95	88	86	81	76	76	71
ARH450	IN DUCT	6	76	82	77	73	70	65	59	53
ARH500	IN DUCT	4	80	96	89	86	83	78	72	66
ARH500	IN DUCT	6	80	81	78	80	71	62	60	52

Access Rectangular In-Line Fans (ARH)

Performance Curve

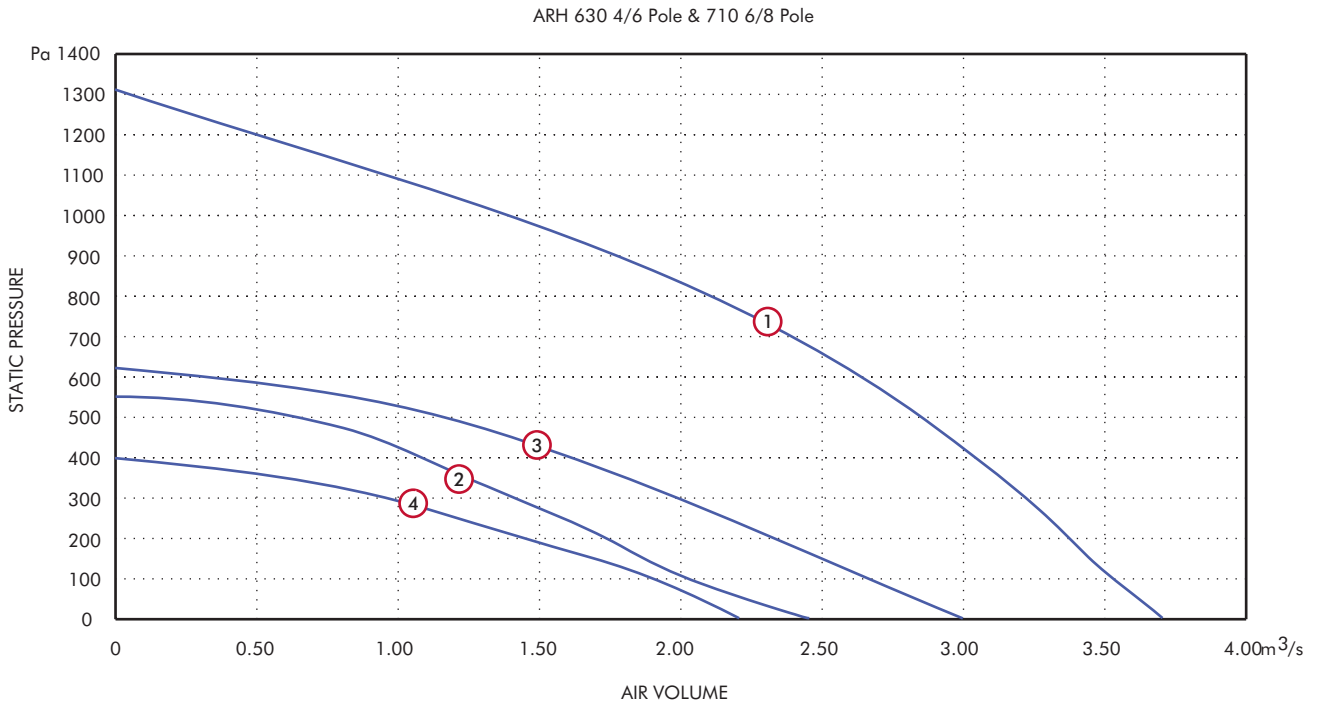

Performance Guide

Duct Size W x H	Phase	Pole	Stock Ref. No.	Curve r.p.m.	Ref.	m³/s at Pa										Motor kW	S.C. Amps	F.L.C. Amps	dBA @ 3m
						0	25	50	100	150	200	250	300	350	400				
850 x 800	3	4	ARH630-34A	1380	①	3.7	3.657	3.612	3.522	3.477	3.39	3.307	3.237	3.141	3.046	4.1	29	6.8	70
850 x 800	3	6	ARH630-36A	890	②	2.453	2.396	2.327	2.218	1.956	1.81	1.478	1.14	0.8	1.2	8	2.6	56	
950 x 850	3	6	ARH710-36A	880	③	3.017	2.904	2.786	2.663	2.481	2.313	1.812	1.989	1.95	14	3.6	60		
950 x 850	3	8	ARH710-38A	650	④	2.297	2.214	2.115	1.903	1.703	1.495	1.201	0.951	0.96	14	1.9	53		

Sound Power Level Spectra dB (re 10⁻¹² Watts)

Stock Ref	Pole	63	125	250	500	1k	2k	4k	8k
ARH630	IN DUCT	4	83	99	94	90	87	85	70
ARH630	IN DUCT	6	84	86	80	77	73	66	56
ARH710	IN DUCT	6	90	87	85	81	77	71	59
ARH710	IN DUCT	8	82	78	78	74	70	63	50

Accessories Dimensions (mm)

Rectangular Attenuators

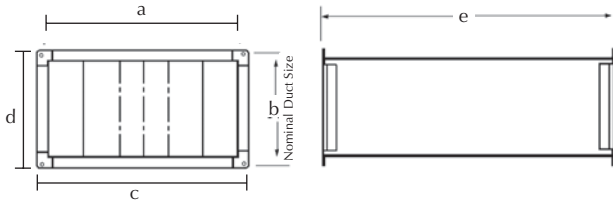

Stock Ref.	a	b	c	d	e	Flange	
						Type	Weight kg
RULDS355	550	485	620	555	1200	Ductmate 35	75
RULDS400	625	535	695	605	1200	Ductmate 35	103
RULDS450	700	600	770	670	1500	Ductmate 35	112
RULDS500	775	700	845	770	1500	Ductmate 35	145
RULDS630	850	800	920	870	1800	Ductmate 35	180
RULDS710	950	850	1020	920	1800	Ductmate 35	203

Mount/Feet Details

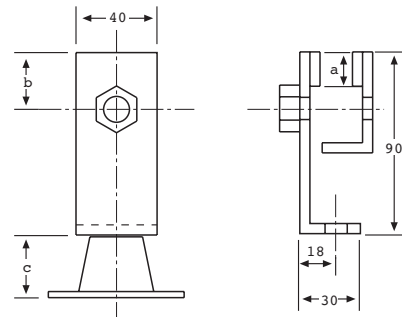

Stock Ref.	a	b	c
PAVM2	35	38	27
PAVM 3	35	38	35

Anti-Vibration Mounts

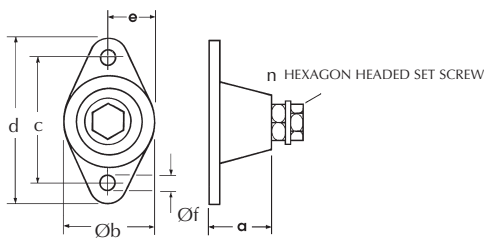

Stock Ref. No.	a	Øb	c	d	e	Øf	n	Max. load kg
10523055	27	37	54	67	18.5	7	M8	36
10523133	35	57	76	95	28.5	10.5	M12	91

Clamp Detail:

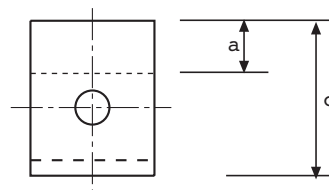

Stock Ref.	a	b	c
PAVM2	35	38	60
PAVM3	35	38	60

Rectangular Flexible Connections



Duct size W x H	Stock Ref. No.
550 x 485mm	LFC355
625 x 535mm	LFC400
700 x 600mm	LFC450
775 x 700mm	LFC500
850 x 800mm	LFC630
950 X 850mm	LFC710

Flexible connections are used to connect rigid ductwork to the rectangular range of ducted fan units. Flexible connections are fitted with flanges and a Duroprene flexible material to prevent vibration transmission. Maximum operating temperature +150°C meets BS476 Part 7 Fire Test.

Rectangular Bag Filter Cassettes

Synthetic bag filter cassettes are available in a range of sizes. The synthetic filter medium is to EU5 (Eurovent 4/5) 94% arrestance. The filter casings are manufactured from galvanised sheet metal fitted with flanges for quick and easy installation. Quick release catches allow the hinged access panel to open for access to the bag filter. Replacement bag filters are available.

Maximum operating temperature +100°C.

Attenuator, Insertion Losses

Impeller Ø	Stock Ref.	Stock							
		63	125	250	500	1k	2k	4k	8k
355	RLDS 355	6	12	23	32	45	45	33	28
400	RLDS 400	6	10	20	31	43	43	33	27
450	RLDS 450	4	9	17	27	36	36	24	13
500	RLDS 500	3	7	14	22	27	21	15	10
450	RLDS 630	4	8	15	24	30	26	14	8
500	RLDS 710	7	15	30	41	45	45	45	32

Access Rectangular In-Line Fans (ARH)

Accessories

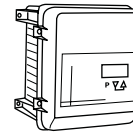
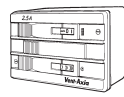
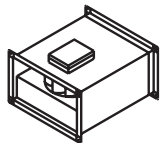

Duct Size W x H	Stock Ref. No.	Electronic controller Stock Ref. No.	Auto transformer Stock Ref. No.	D.O.L starter & Overload Stock Ref. No.	*eDemand Controller		
					Voltage Control Stock Ref.	1/3 Phase Inverter Stock Ref.	3 Phase Inverter Stock Ref.
550 x 485	ARH35514A	W10303102M	10314103	444744 + 444702	444164	-	-
550 x 485	ARH35534A	-	10314301	444747 + 444698	444166	444177	444172
625 x 535	ARH40014A	10303106A	10314105	444744 + 444702	444164	-	-
625 x 535	ARH40034A	-	10314301	444747 + 444700	444166	444177	444172
700 x 600	ARH45014A	10303106A	10314107	444744 + 444704	444165	-	-
700 x 600	ARH45034A	-	10314304	444747 + 444702	444166	444177	444173
775 x 700	ARH50034A	-	10314304	444747 + 444702	444166	444177	444173
850 x 800	ARH63034A	-	10314307	444747 + 444704	444167	-	444174
550 x 485	ARH35516A	W10303102M	10314103	444744 + 444699	444164	-	-
550 x 485	ARH35536A	-	10314301	444747 + 444698	444166	444177	444172
625 x 535	ARH40016A	W10303102M	10314103	444744 + 444701	444164	-	-
625 x 535	ARH40036A	-	10314301	444747 + 444698	444166	444177	444172
700 x 600	ARH45016A	W10303102M	10314103	444744 + 444702	444164	-	-
700 x 600	ARH45036A	-	10314301	444747 + 444699	444166	444177	444172
775 x 700	ARH50036A	-	10314304	444747 + 444701	444166	444177	444172
850 x 800	ARH63036A	-	10314304	444747 + 444702	444166	444177	444173
950 x 850	ARH71036A	-	10314304	444747 + 444702	444166	444177	444173
950 x 850	ARH71038A	-	10314304	444747 + 444701	444166	444177	444172

* For full range of speed controller options, see Accessories & Controllers Section

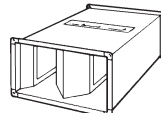
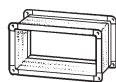
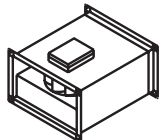

Duct Size W x H	Stock Ref. No.	Rectangular flexible connection Stock Ref. No.	Rectangular attenuator Stock Ref. No.	Mounting Feet & AV's
550 x 485	ARH35514A	LFC355	RULDS355	PAVM2
550 x 485	ARH35534A	LFC355	RULDS355	PAVM2
625 x 535	ARH40014A	LFC400	RULDS400	PAVM3
625 x 535	ARH40034A	LFC400	RULDS400	PAVM3
700 x 600	ARH45014A	LFC450	RULDS450	PAVM3
700 x 600	ARH45034A	LFC450	RULDS450	PAVM3
775 x 700	ARH50034A	LFC500	RULDS500	PAVM3
850 x 800	ARH63034A	LFC630	RULDS630	PAVM3
550 x 485	ARH35516A	LFC355	RULDS355	PAVM2
550 x 485	ARH35536A	LFC355	RULDS355	PAVM2
625 x 535	ARH40016A	LFC400	RULDS400	PAVM3
625 x 535	ARH40036A	LFC400	RULDS400	PAVM3
700 x 600	ARH45016A	LFC450	RULDS450	PAVM3
700 x 600	ARH45036A	LFC450	RULDS450	PAVM3
775 x 700	ARH50036A	LFC500	RULDS500	PAVM3
850 x 800	ARH63036A	LFC630	RULDS630	PAVM3
950 x 850	ARH71036A	LFC710	RULDS710	PAVM3
950 x 850	ARH71038A	LFC710	RULDS710	PAVM3

